

# RADIOBAND 3G



**RB3 T868**

**RB3 R868**

## USER'S MANUAL

# Index

<b>INTRODUCTION</b> .....	<b>3</b>
Operating .....	3
Receiver RB3 R868 .....	4
Transmitter RB3 T868 .....	5
<b>ASSEMBLY AND INSTALLATION</b> .....	<b>6</b>
1 Installation of the equipment .....	6
2 Connecting the receiver to the control panel.....	7
2.1 Adjustment of the receiver / Operating modes.....	8
2.2 ON/WORK mode.....	8
2.3 ATEST signal .....	9
3 Connecting the safety edge to the transmitter (connection examples).....	10
<b>PROGRAMMING</b> .....	<b>12</b>
4 Programming .....	12
4.1 MODE 1: Safety edge connected to IN1 activates R1 .....	13
4.2 MODE 2: Safety edge connected to IN1 activates R2 .....	14
4.3 MODE 3: Safety edge connected to IN1 activates R1 and R2.....	15
4.4 MODE 4: Safety edge connected to IN1 activates R1 and safety edge connected to IN2 activates R2 .....	16
<b>CHECKING AND MAINTENANCE</b> .....	<b>17</b>
5 Does the equipment work properly?.....	17
6 CHECK function .....	18
7 Troubleshooting .....	19
8 Total reset .....	20
9 Batteries .....	20
Technical data summary .....	21
Important safety instructions .....	22
Notes .....	23
EC Declaration of conformity .....	24

# INTRODUCTION

## Operating

The RadioBand system is designed for Commercial and Domestic door applications where a safety edge is used.

The system provides a wireless system replacing spiral cables or energy chain systems to provide the safety signal to the door or gate control panel.

The receiver continuously monitors the status of transmitters connected to it.

With the system you can support 8,2 KOhm safety edges and also optical low power systems. Additionally you can connect 0 Ohm contacts for slack ropes and wicket doors. The signal will be transferred by radio.

When an obstacle is detected, the RadioBand system turns its output in a safety state, changing the state of the receiver relay.

Up to three transmitters per output can be connected to the receiver. There are two outputs on each receiver that can be connected to the control panel as 8k2 or NC (normally closed) contact.

**The system complies with EN ISO 13849-1:2008, category 2, PLd. Certified by TÜV NORD CERT GmbH.**

# Receiver RB3 R868



Compatible equipment: RB3 T868,  
RB3 TGL868 and RB3 TGLA868

LED	ON	OFF
R1	Safety edge on relay 1 activated or not connected	Normal use
R2	Safety edge on relay 2 activated or not connected	
R3	SW1:3 ON - Low battery indicator SW1:3 OFF - Same as R1 / R2	
CHECK	See signal coverage table	

## CHECK BUTTON

Check system operation

## LEDS

## PROGRAMMING BUTTON

Program new transmitters

## MR JUMPER

Reset transmitters in memory

## OPTION SELECTOR

SW	FUNCTION	ON	OFF
SW 1	Autocheck Period	7sec.	30sec.
SW 2	Operating mode	ON	WORK
SW 3	R3	Low battery	R3=R1/R2
SW 4	ATEST Polarity		

## ATEST INPUT

12/24V AC/DC 5 mA input for testing the system (SW4) and / or activation of the safety edge (SW2)

## R3 OUTPUT

Low battery indication or active element output (SW3)

## 12/24V AC/DC

Power supply (9-35V DC, 8-28V AC)

## R1 / R2 OUTPUTS

Relay outputs to inform the control panel of the state of the safety edge, normally closed contact (CS) and 8k2 (BS) for each relay

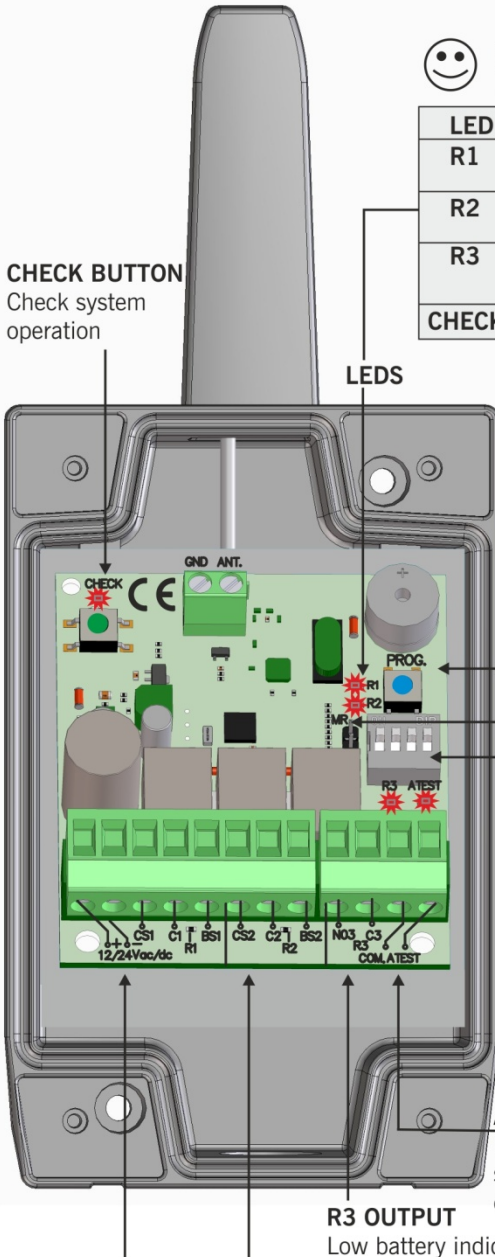



# Transmitter RB3 T868

## IN1 AND IN2 INPUTS

Connection of up to 2 safety edges

## BATTERY CONNECTOR

Connect the batteries for operation

**Do not carry the equipment with batteries connected**

## PROGRAMMING BUTTON

Program the transmitter to the receiver

**BATTERIES 2X3,6Vdc (ER14505 AA Type)**

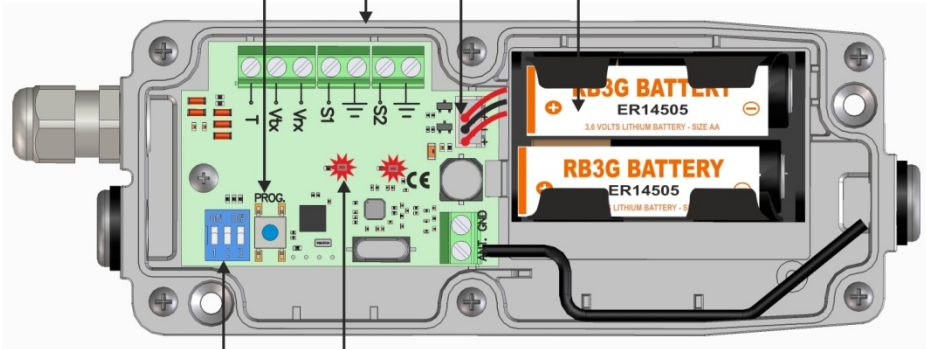

## LEDs

IN1 and IN2 safety edge state indicators

LED input status	
OFF	Safety edge well connected and working properly
ON	Safety edge pressed or not connected
Flash	Input not programmed

## OPTION SELECTOR

IN 1	SW 1	SW 2
Optical safety edge always activated (OSE-S7502)	OFF	OFF
Standard optical safety edge	ON	OFF
8k2 resistive safety edge	OFF	ON
Safety contact NC	ON	ON

IN 2	SW 3
Safety contact NC	ON
8k2 resistive safety edge	OFF

# ASSEMBLY AND INSTALLATION



## 1 Installation of the equipment



RECEIVER

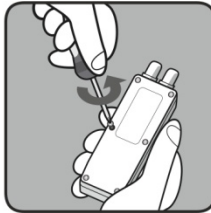

TRANSMITTER

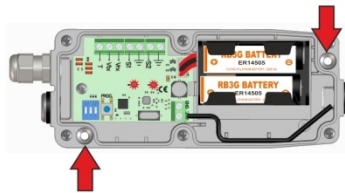
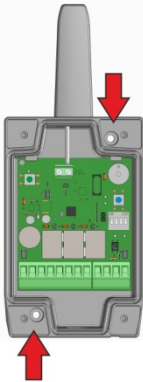
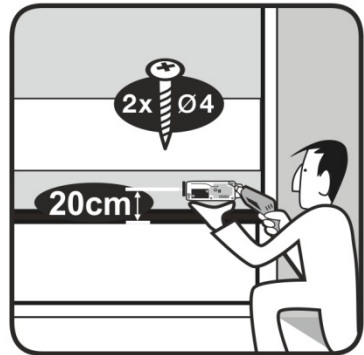

### IMPORTANT

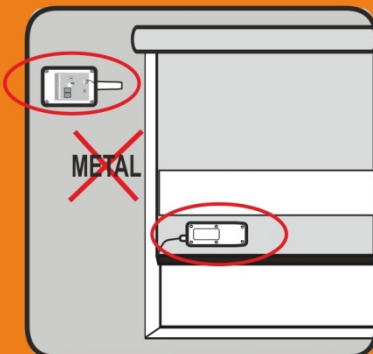

Do not place metal surfaces between transmitter and receiver.

For maximum range, both the receiver and transmitters must be installed with the same orientation (vertical or horizontal).

# 2

## Connecting the receiver to the control panel

Connecting the safety outputs to control panel.

Example: connection to control panel with safety contact / STOP input

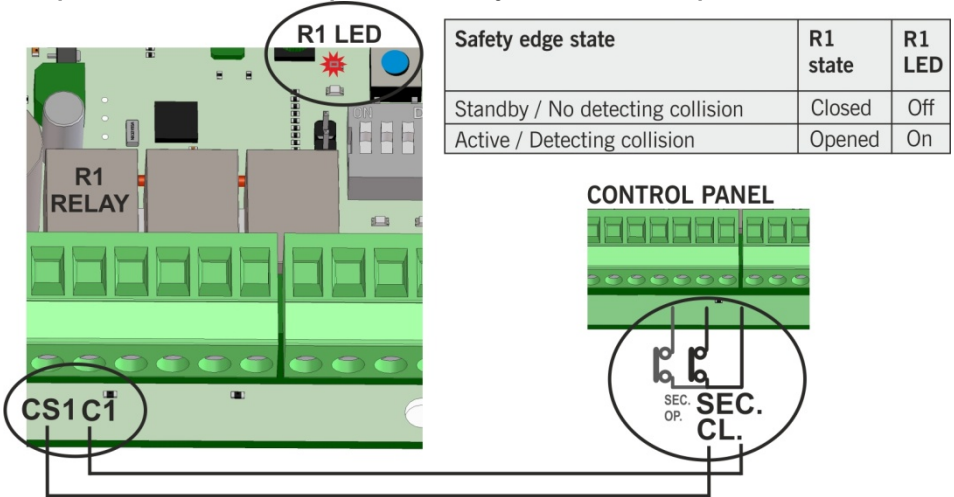

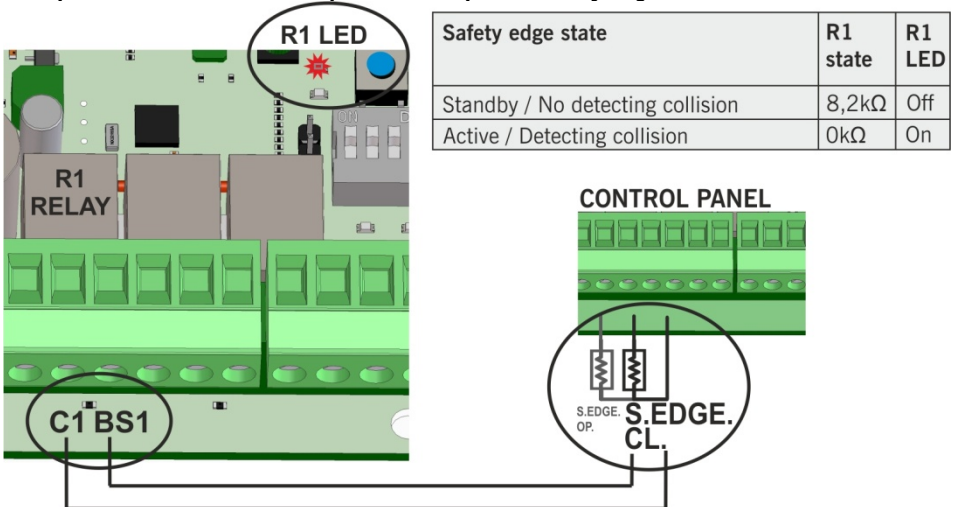

Example: connection to control panel with input for safety edge 8k2



The equipment can be connected to the control panel with input for safety edge 8k2 or directly into a safety input normally closed contact as if it were a photocell or stop signal.

This connectivity exists for R1 and R2 outputs.

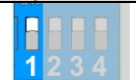
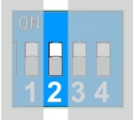
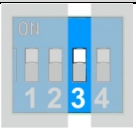
## 2.1 Adjustment of the receiver / Operating modes.

Autocheck period				
SW1		↑	7 s	The system performs a complete test of the equipment, including radio communication.
		↓	30 s	
Operating mode with optical safety edges				
SW2		↑	ON	In ON mode, only "always on" optical safety edges (OSE-S7502) are permitted, as the optical element always is on. In WORK mode, the optical elements are OFF meanwhile the ATEST signal is active. So it is necessary to disconnect this ATEST signal during the door movement.
		↓	WORK	
With resistive or mechanical safety edges, the selector does not work because it is not necessary to activate the sensors.				
R3 function				
SW3		↑	Low battery	In low battery indication mode, the relay contact is closed when any of the transmitters has an insufficient level of battery. In ALARM mode, the relay contact is closed to indicate that any of the safety edges stored in the receiver are active.
		↓	Alarm	
ATEST signal polarity (depends on the control panel)				
SW4		↑	Negative	ATEST negative: ATEST signal is a fixed 12 or 24V signal that the control panel sets to 0V to make the system check. ATEST positive: ATEST signal is disconnected and when the control panel makes a testing gives a 12 or 24V signal.
		↓	Positive	

In case of operating without ATEST signal, it is necessary to work in ATEST positive way. In order to comply with the EN ISO 13849-1: 2008 safety standard, you must connect this signal to test the system.

## 2.2 ON/WORK mode

The operating mode is selected by the SW2 of the receiver. This selector is necessary when working with optical safety edges. All transmitters in the receiver work in the same way. **It will be necessary to reset the receiver when changing the operating mode with transmitters already memorized.**

With **standard optical safety edges**, WORK mode must be used due to high consumption of the optical elements.

With OSE-S7502 **"always on" optical safety edges**, both modes are allowed. In ON mode, the system becomes universal for any control panel. In WORK mode the battery life is maximized thanks to the shutdown of the optical elements.

## 2.3 ATEST signal

In order to comply with EN ISO 13849-1: 2008 safety standard, a signal to test the system must be connected.

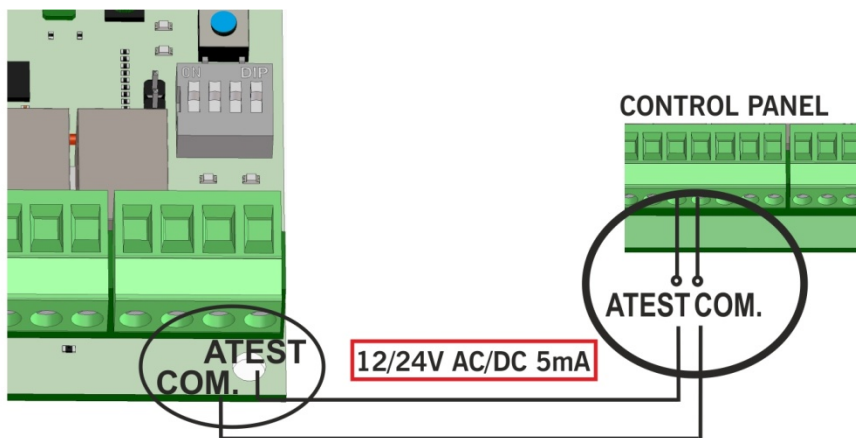

### ON MODE

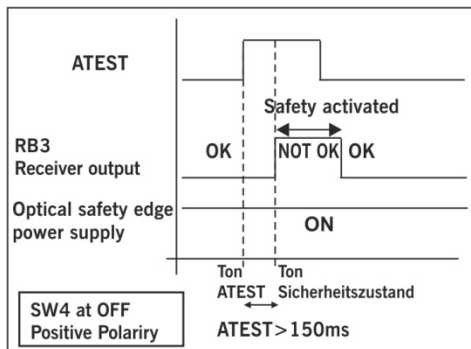

### WORK MODE

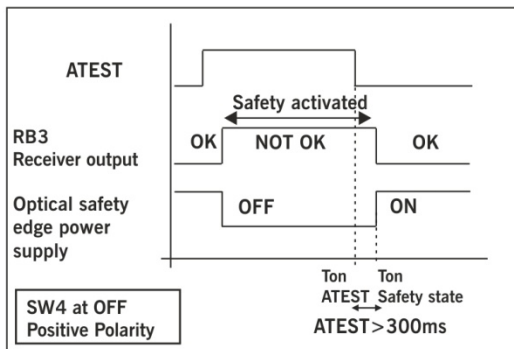

When working with optical safety edges, in ON mode, only OSE-S7502 are allowed as they are kept always active. The radio communication is tested every 7 or 30 seconds depending on the selector SW1 of the receiver.

In WORK mode, the ATEST signal is used to power up and down the optical safety edges. The radio communication is tested as in ON mode and when the optical elements are powered up and down.

# 3

## Connecting the safety edge to the transmitter (connection examples)

### 8k2 RESISTIVE / MECHANICAL OR CONTACT SAFETY EDGE

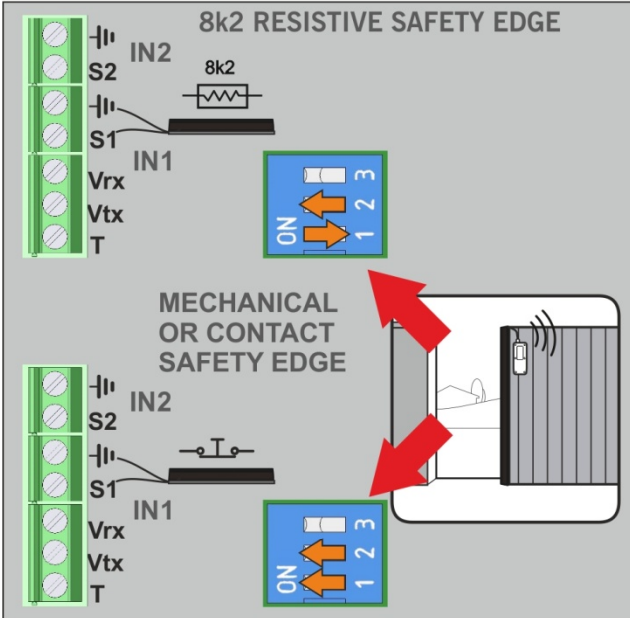

**IMPORTANT**

The position of the selector must correspond to the type of safety edge connected.

IN 2 only supports 8k2 resistive and mechanical / contact safety edges. The selector 3 is not applicable if nothing is connected to IN2.

### OSE-S7502 "ALWAYS ON" OPTICAL SAFETY EDGE

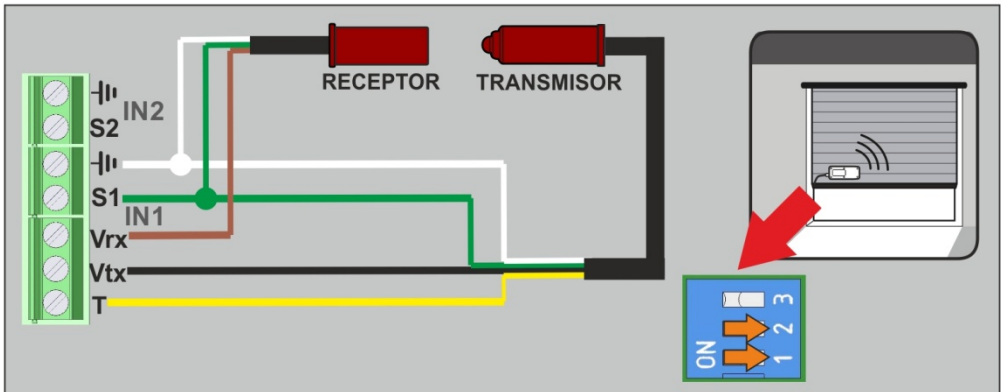

### STANDARD OPTICAL SAFETY EDGE (Only used with ATEST function)

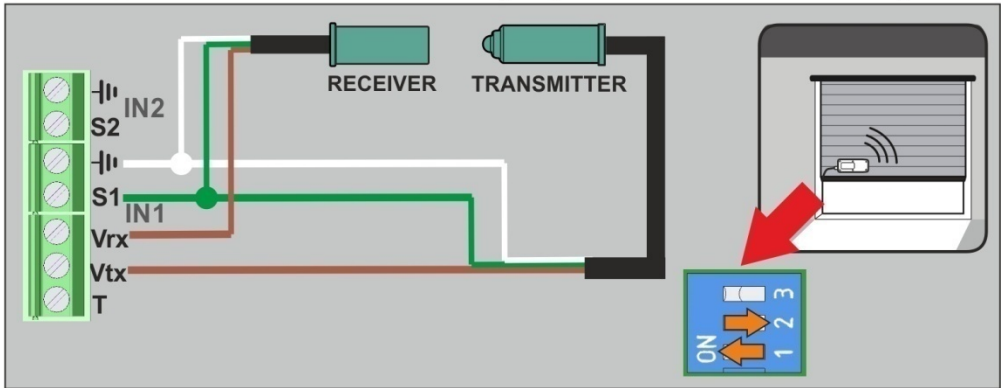

### OSE-S7502 "ALWAYS ON" OPTICAL SAFETY EDGE AND WICKET DOOR CONTACT

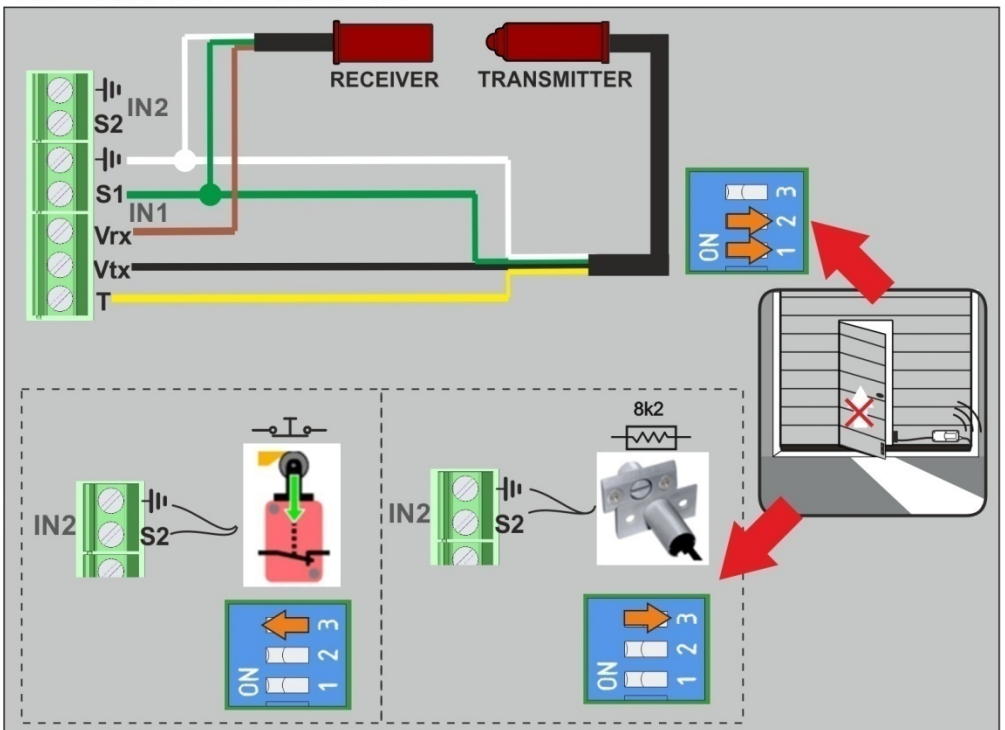



# PROGRAMMING

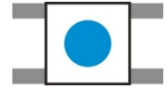

## 4 Programming

- **Working with one safety edge**, it must be connected to IN1 of the transmitter. IN2 does not work.

This band can work on R1 (mode 1) or R2 (mode 2) or simultaneously on the 2 relays (mode 3).

- **Working with two safety edges (mode 4)**, the safety edge connected to IN1 act on R1 and the safety edge IN2 connected on R2.  
In IN2 only mechanical band / contact or 8k2 band is allowed.

Before programming, place the options selectors at the desired position. Any subsequent change will require a receiver reset and reprogramming.

Press the PROG button and hold it until the desired mode is selected. LED's for R1 & R2 will flash in sequence to select the correct operation mode.

There are **four programming modes**, depending on the inputs you wish to use of the transmitter and the outputs required to activate on the receiver.

MODE	
1	<b>IN1</b> ⇔ <b>R1</b> : Safety edge in IN1 on transmitter activates R1 on receiver
2	<b>IN1</b> ⇔ <b>R2</b> : Safety edge in IN1 on transmitter activates R2 on receiver
3	<b>IN1</b> ⇔ <b>R1+R2</b> : Safety edge in IN1 on transmitter activates R1 and R2 on receiver
4	<b>IN1</b> ⇔ <b>R1</b> and <b>IN2</b> ⇔ <b>R2</b> : Safety edge in IN1 on transmitter activates R1 on receiver and safety edge in IN2 on transmitter activates R2 on receiver



## 4.1 MODE 1: Safety edge connected to IN1 activates R1

Safety edge connected in IN1 will activate R1.  
Employed receiver memory = 1 transmitter

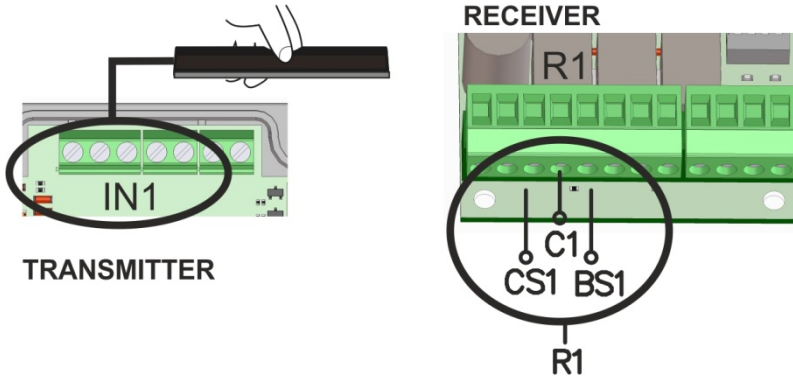

### Programming sequence:

- Press PROG button on the receiver (1) until R1 LED lights (2).
- Press PROG button on the transmitter (3).
- A beep will be heard on the receiver indicating the transmitter is properly programmed (4).

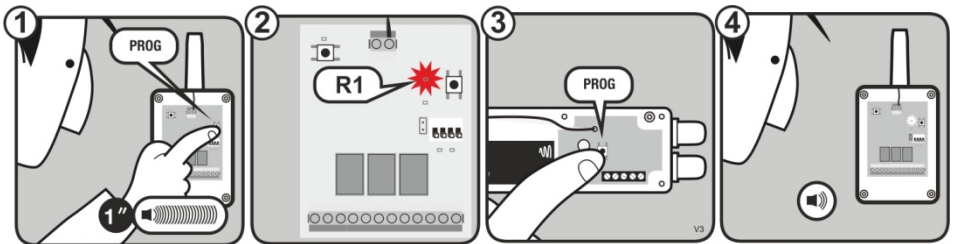

- To exit programming mode, wait for 10 seconds or press PROG button on the receiver. Two beeps will be heard.

## 4.2 MODE 2: Safety edge connected to IN1 activates R2

Safety edge connected in IN1 will activate R2.  
Employed receiver memory = 1 transmitter

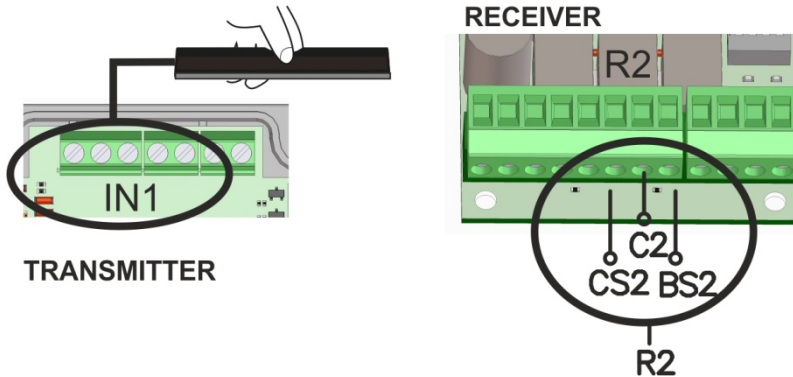

### Programming sequence:

- Press PROG button on the receiver (1) until R2 LED lights (2).
- Press PROG button on the transmitter (3).
- A beep will be heard on the receiver indicating the transmitter is properly programmed (4).

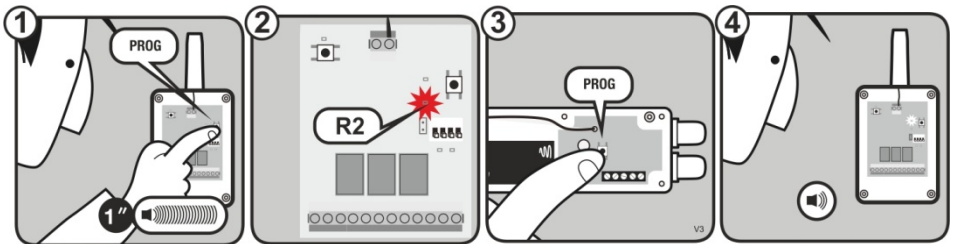

- To exit programming mode, wait for 10 seconds or press PROG button on the receiver. Two beeps will be heard.

## 4.3 MODE 3: Safety edge connected to IN1 activates R1 and R2

Safety edge connected in IN1 will activate R1 and R2.

Employed receiver memory = 2 transmitters

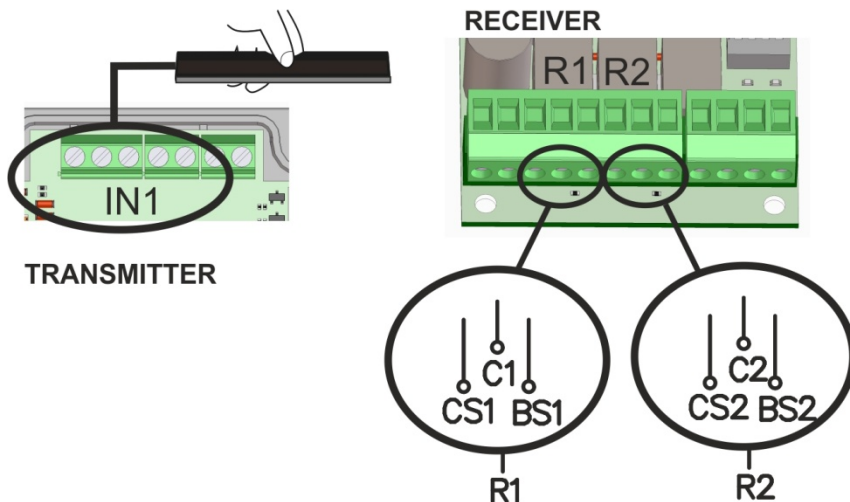

### Programming sequence:

- Press PROG button on the receiver (1) until R1 LED and R2 LED light (2).
- Press PROG button on the transmitter (3).
- A beep will be heard on the receiver indicating the transmitter is properly programmed (4).

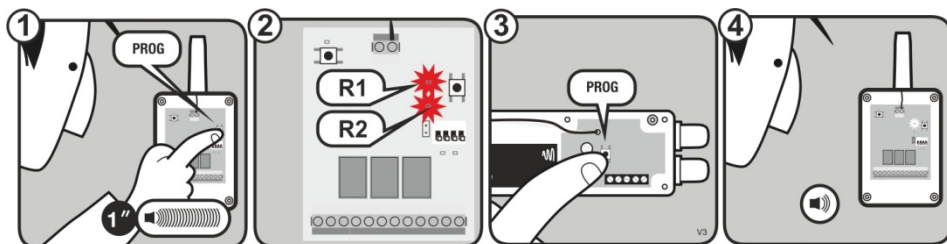

- To exit programming mode, wait for 10 seconds or press PROG button on the receiver. Two beeps will be heard.

## 4.4 MODE 4: Safety edge connected to IN1 activates R1 and safety edge connected to IN2 activates R2

Safety edge connected in IN1 will activate R1 and IN2 will activate R2.  
Employed receiver memory = 2 transmitters

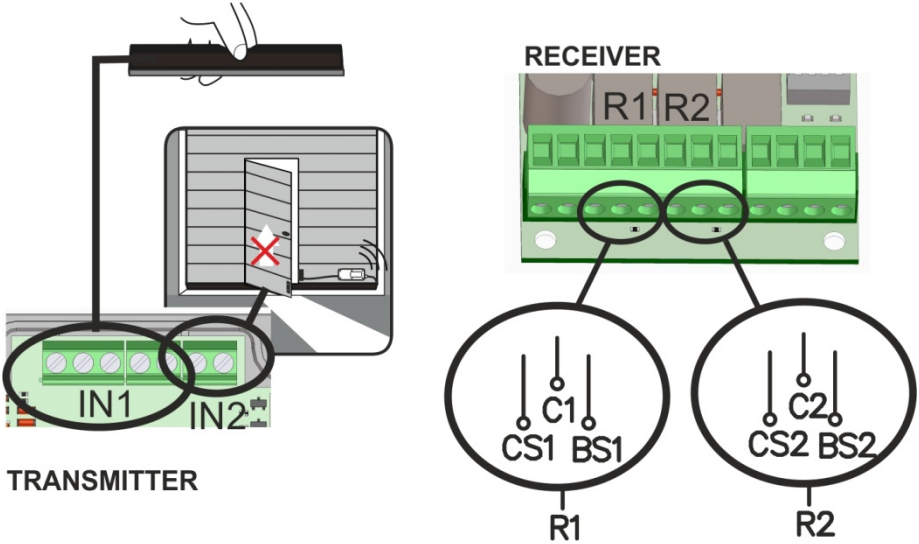

### Programming sequence:

- Press PROG button on the receiver (1) until R1 LED and R2 LED flash (2).
- Press PROG button on the transmitter (3).
- A beep will be heard on the receiver indicating the transmitter is properly programmed (4).

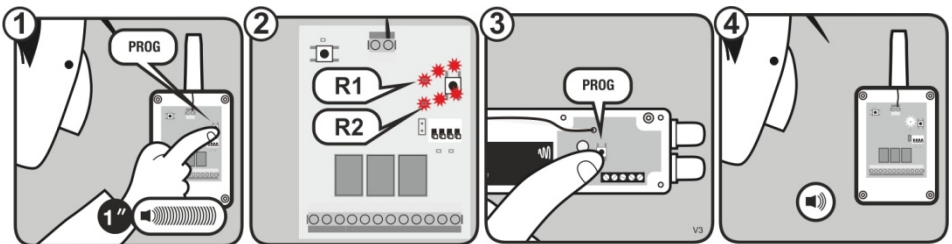

- To exit programming mode, wait for 10 seconds or press PROG button on the receiver. Two beeps will be heard.

# CHECKING AND MAINTENANCE



## 5 Does the equipment work properly?

Once the safety edge is wired and programmed into the receiver, R1 and / or R2 (according to programming mode) is at standby state (off), also IN1 and IN2 at the transmitter.

If the safety edge has been programmed in R1 and R1 LED is at ON, check that the safety edge is not pushed/detecting (IN1 LED at ON on the transmitter) or it is not properly configured (IN1 LED flashing on the transmitter). If IN1 LED is at OFF and R1 LED is at ON, check status of other transmitters memorized.

The IN1 and IN2 LEDs of the transmitter will pass to battery saving mode (off) 5 minutes after pressing PROG on the transmitter. They can re-awaken again pressing the PROG button on the transmitter.

If there is no safety edge programmed in R1 and / or R2, it will be in safety mode (opened and LED at ON)

If R1 / R2 LEDs are at OFF, but the door does not move, check that the wiring to the control panel is made correctly as safety contact or 8k2 input resistive safety edge.

# 6











## CHECK function

### Ideal to know the radio coverage of the installation.

Press the receiver's CHECK button for at least 1 second to enter check mode. The indicator light will come on and four beeps will be heard.

Perform a complete door opening and closing manoeuvre. During the system check a beep will be heard every 1,5 seconds. If you have not heard any other acoustic signal at the end of the manoeuvre, the system works properly. If during the verification, the communication with a transmitter fails or the communication is poor, the receiver emits three consecutive beeps indicating that an error occurred.

Press all the safety edges installed to detect which one has failed.













	N° FLASHES CHECK LED	SIGNAL COVERAGE	RESULT OF CHECK
		Very weak	Safety edge failure
		Weak	Ok
		Normal	Ok
		Good	Ok
		Very good	Ok

Low signal coverage increases battery consumption.

To exit Check mode, press the CHECK button or wait 5 minutes. On exiting check mode, seven consecutive beeps will be heard and the indicator light will flash continuously in case of failure.

It is recommended to perform a CHECK function at the end of the installation process to ensure a proper system operation.

Press the PROG button to display the status of the LEDs on the transmitter RB3 T

RB3 R		RB3 T		MESSAGE/ERROR	SOLUTION
R1/R2 LED		ATEST LED			
		BEEPS		Detection of the safety edge	Verify that the IN1/IN2 LED of the RB3 T is at ON when you press PROG button of RB3 T, to check the correct operation.
				Receiver with another transmitter in memory	Check the IN1 / IN2 state of all RB3 T installed. RESET memory and reprogram to ensure not having other transmitters in memory
				Communication failure between RB3 R and RB3 T	Verify the radio signal with the CHECK function
				The safety edge is not detected correctly (not connected or not programmed) or the position of the selector is incorrect	Reset the system. Connect correctly, check selector or program the safety edge transmitter into the receiver
				RB3 T low battery or communication loss between equipments	Verify the batteries of the transmitter and / or presence of interferences (CHECK function)
		4x  / 5s		RB3 receiver is in WORK mode waiting for a TEST signal	---
				Check function. See coverage and signal quality table	---
		1x 	---	Receiver memory full. Indication when trying to memorize a new transmitter	Reset the system and reprogram the equipment. Maximum 6 safety edges per receiver (3 per relay)
		4x 	---	Change of operating mode in the RB3 R with transmitters already memorized	Reset the system, change SW2 on the receiver to the desired position and reprogram the equipments
		7x 	---		

## 8 Total reset

- Press PROG button on the receiver (1) until the R1 LED lights on (2).
- Keep the programming PROG button pressed down and make a bridge with the “MR” reset jumper (3).
- The receiver will emit 10 warning sound signals (3), and then more at a faster frequency, indicating that the operation has been carried out (4).

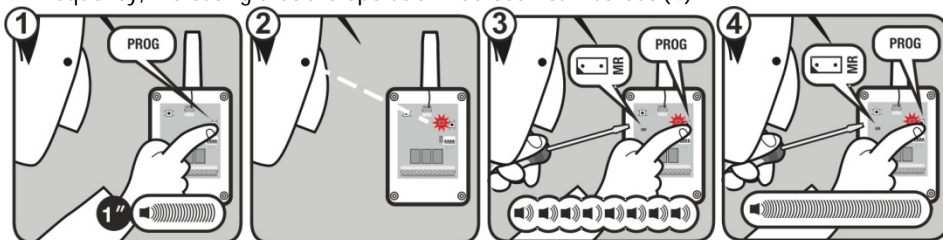

- To exit programming mode, wait for 10 seconds or press PROG button on the receiver. Two beeps will be heard.

## 9 Batteries

### Storage

- Store the lithium cells in a cool, dry and ventilated area far from fires and heating sources.
- It is recommended the use of a non-combustible structure and keep adequate clearance between walls and batteries.
- The maximum temperature suggested for the storage is +30°C.
- Higher temperatures are allowed but cause an increase in the self discharge of the battery and speed up the process of passivation.
- In any case, never go over 100°C, as the batteries can break and cause a leakage.
- Arrange adequate protections to avoid possible damages to the batteries.
- Keep the batteries in their original packages until they are used.
- Do not expose the batteries directly to the sun light.
- Do not put a higher number of cartons one on another (respect what indicated).
- If in the same place are storage batteries with a total capacity >50,000Ah, it is suggested to install an alarm for smoke and gas.

### Usage

- If the battery is integral, store and handle with care (it is suggested to handle the batteries in a ventilated place, do not smoke, eat or drink during the assembly).
- Do not expose at temperature higher than 100°C (it is recommended <85°C).
- Avoid short circuit, crush, and exposition to heat sources.
- Do not disassemble the batteries or the battery packs, do not throw them in the fire, do not perforate them, do not overheat or wet them.
- Material to avoid: water, oxidizing agents, alkalis.



# Technical data summary

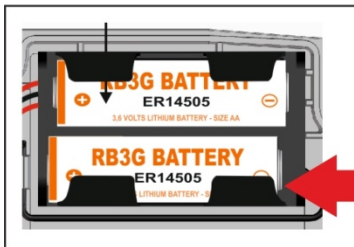
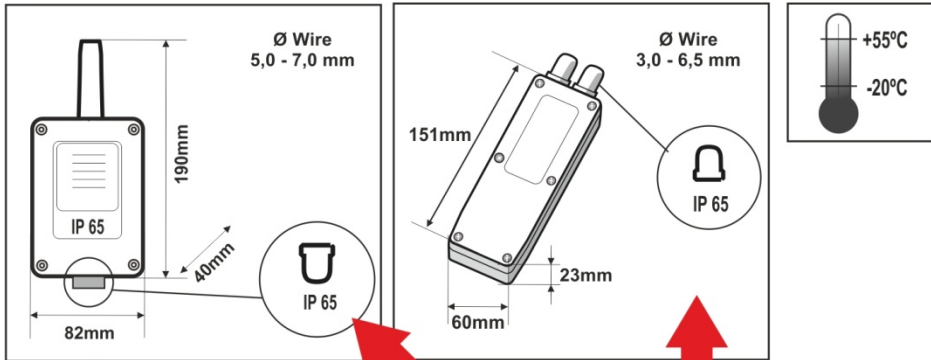

Glands must be installed to ensure IP65. Replace glands for caps on the cable entries that are not used.

Battery Duration: 2 years approximately. Do not mix new and old batteries.

	<b>RB3 R868</b>	<b>RB3 T868</b>
<b>Frequency</b>	Multifrequency system 868 MHz auto-adjustable (Channel 1: 868,700 -869,200MHz, Channel 2: 868,000 -868,600MHz; Channel 3: 869,400 -869,650MHz; Channel 4: 869,400 - 869,650MHz)	
<b>Memory</b>	6 transmitters (3 on relay 1, 3 on relay 2)	---
<b>Operating consumption</b>	Max 255mA	12mA
<b>Radiated power</b>	< 25mW	
<b>Range (in open field)</b>	50 m	
<b>Reaction time (typical)</b>	35ms	
<b>Maximum reaction time when interferences</b>	220ms	
<b>Compatible equipments</b>	RB3 T868, RB3 TGL868 and RB3 TGLA868	RB3 R868 and RSEC3

The manufacturer reserves the right to change the specification of the equipment without prior warning.

# Important safety instructions

Disconnect the power supply whenever you proceed to the installation or repair of the control panel.

In accordance with the European low voltage directive, you are informed of the following requirements:

- For permanently connected equipment, an easily accessible connection device must be incorporated into the cabling.
- This system must only be installed by a qualified person that has experience with automatic doors/gates and knowledge of the relevant EU standards.
- The instructions for use of this equipment must always remain in the possession of the user.
- The frequency of the RadioBand system does not interfere in any way with the 868 MHz remote control systems.
- **Follow all recommendations given in this manual to prevent serious danger to people.**

**More tips, interactive demos  
and online videos**

# Notes

# EC Declaration of conformity

See web [www.jcm-tech.com/declarations/](http://www.jcm-tech.com/declarations/)

JCM TECHNOLOGIES, S.A. declares herewith that the product RB3 R868 and RB3 T868 complies with the requirements of the 1999/5/ CEE R&TTE Directive, and complies with the fundamental requirements of the 2006/42/CE Machine Directive, 2004/108/EC Directive on electromagnetic compatibility and 2006/95/EC on low voltage, insofar as the product is used correctly.

In order to comply with the EN 12978:2003 product standard and assure the correct operation of the system, it is mandatory to follow the instructions below, to avoid serious dangerous to persons.

- SW1:1 is allowed to be set at ON, only if the door cycle is between 7s and 30s.
- SW1:1 is allowed to be set at OFF, only if the door cycle is greater than 30s.

Note: If the door cycle is smaller than 7s, the system must be used only in WORK mode.

**The system complies with EN ISO 13849-1:2008, category 2, PLd. Certified by TÜV NORD CERT GmbH.**

