



User's Manual

**ML8NF
RB3**

EN

Table of contents

Maintenance	3
Important safety instructions for installation.....	3
Important safety instructions for use.....	3
Use of the equipment.....	3
Technical Data	4
Connection	5
Installation	6
Installation with support.....	6
Installation without support.....	6
Door Positioning.....	6
Programming	7
Radio Manual Programming.....	7
Total Reset.....	7
Safety devices programming	8
RadioSens3 Transmitter Programming in RSEC3 Receiver.....	8
Adjust the sensitivity and inhibition point.....	8
Maneuver programming	9
Programming the door maneuver with RadioSens3 system.....	9
Inputs, outputs, dip-switches & radio inputs	10
Regulatory Data	10
EU Declaration of conformity.....	10

Maintenance

Important safety instructions for installation



Disconnect the power supply whenever you proceed to the installation or repair of the control panel.

- The panel must be installed while the power is disconnected.
- Before installing the panel, remove all unnecessary ropes or chains and disable any equipment such as locks that is not necessary for the automatic operation.
- Before installing the panel, check that the door is in good mechanical condition, correctly balanced and that it opens and closes correctly.
- Install the manual unlocking device at a height lower than 1.8m.
- Install any permanent control next to the door away from any moving part and at a minimum height of 1.5m.
- For permanently connected equipment, an easily accessible power disconnection device must be incorporated into the wiring. It is recommended that this be of the emergency switch type.
- If the control panel is supplied without emergency stop button, this will be incorporated in the installation, connecting it to the STOP terminal.
- For correct use of the security edge, this must never be activated when the door is fully closed. It is wise to install the ends of run before activating the edge.
- This equipment can only be handled by a specialist fitter, by maintenance staff or by a suitably trained operator.
- To connect the power supply and motor wiring, 2.5 mm² section terminals must be used.
- Use protective goggles when handling the equipment.
- Fuses must only be handled when the appliance is disconnected from the mains.
- The instructions for using this equipment must remain in the possession of the user.
- European door normative EN 12453 and EN 12445 specify the following minimum protection and door safety levels:
 - for single-family dwellings, prevent the door from making contact with any object or limit the force of contact (e.g. safety band), and in the case of automatic closing, it is necessary to complement this with a presence detector (e.g. photocell).
 - for communal and public installations, prevent the door from making contact with any object or limit the force of contact (e.g. safety band), and complement this with a presence detector (e.g. Photocell).

Important safety instructions for use

- Do not allow children to play with the door controls.
- Keep the remote controls out of the reach of children.
- Watch the door movement and keep people away until the door is fully open or closed.
- Precaution when operating the manual unlocking device, as the door may suddenly fall due to the bad condition of the springs or door unbalance. Details on how to use the manual unlocking device must be provided by the manufacturer or the device installer.
- Examine the installation frequently, especially the cables, springs and supports, to detect signs of wear, damage or unbalance. Do not use the door if repair work or adjustments are required, as this may cause damage.

Use of the equipment

Designed for automation of garage doors, in accordance with the general description. Not guaranteed for other uses. The manufacturer reserves the right to alter equipment specifications without prior notification.

Technical Data

Parameter	Value
Frequency	868,35 MHz
Codification	High security rolling code
Memory	27 codes (expandable to 500 codes with memory card)
Power supply	230Vac ±10%
Maximum motor power	750W / 1200W (intensive use / residential use)
Standby /operating consumption	23mA / 43mA
Motor fuses	6A
Optional cards	RSEC3 + MEM 500 + V-XPAN + TL-CARD-V
Free voltage output	2 outputs
12Vdc output	1 fix (100mA) + 1 configurable (100mA)
Manoeuvre time	1 second – 6 minutes
Operating temperature	-20°C to +55°C
Watertightness	IP32
Size	180 x 152 x 88mm

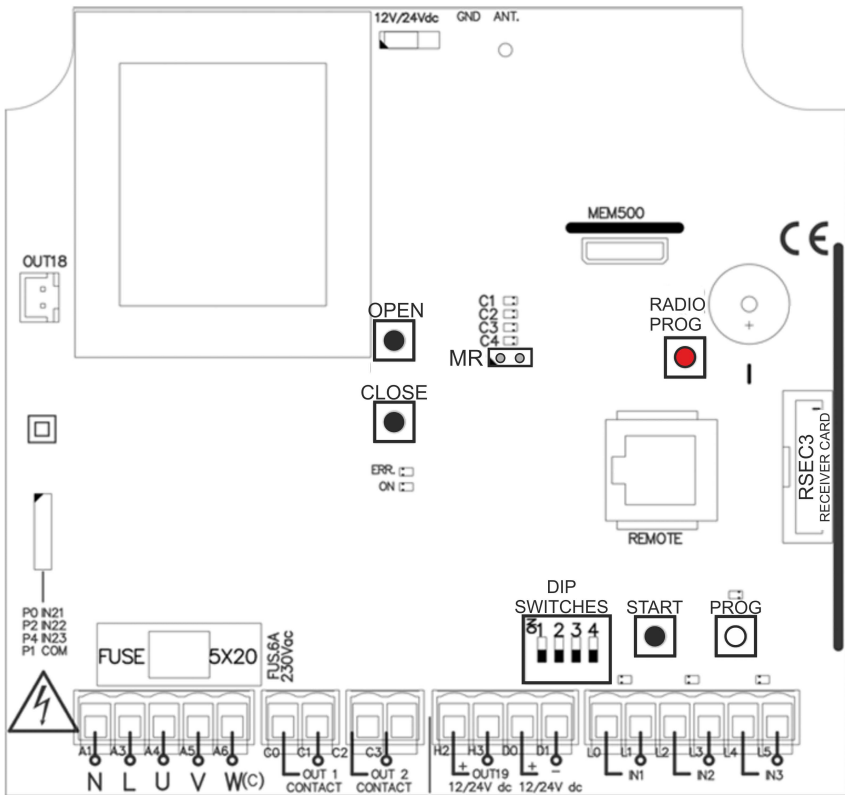

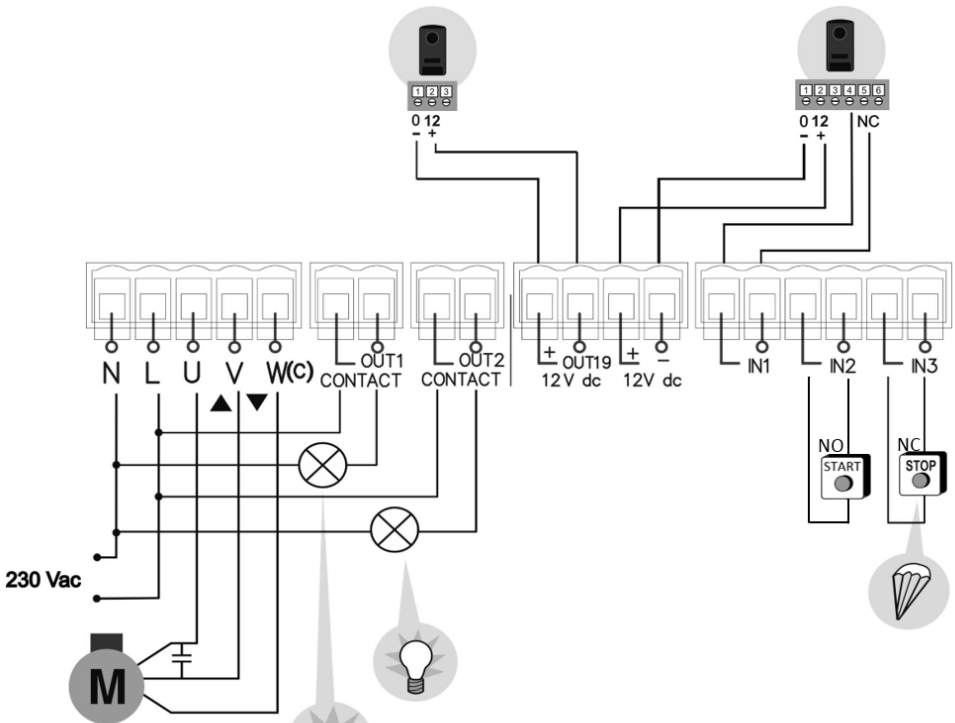

Motor connections:

U=OPEN (Brown)

V=CLOSE (Black)

W(c)=COMMON (Blue) If motor runs in wrong direction, de-power and swap brown and black cables.

Installation

Installation with support

UNSCREW



EXTRACT SUPPORT



DRILL WALL



HANG CONTROL PANEL



SCREW



Installation without support

UNSCREW



OPEN TOP



DRILL WALL



Door Positioning

PRESS WHITE PROG
BUTTON 2 SECS



PRESS & HOLD CLOSE

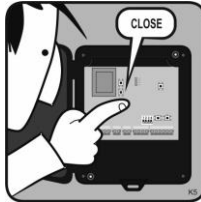

DOOR CLOSES



DOOR CLOSED



Programming

Radio Manual Programming (Remote controls, wireless buttons, etc)

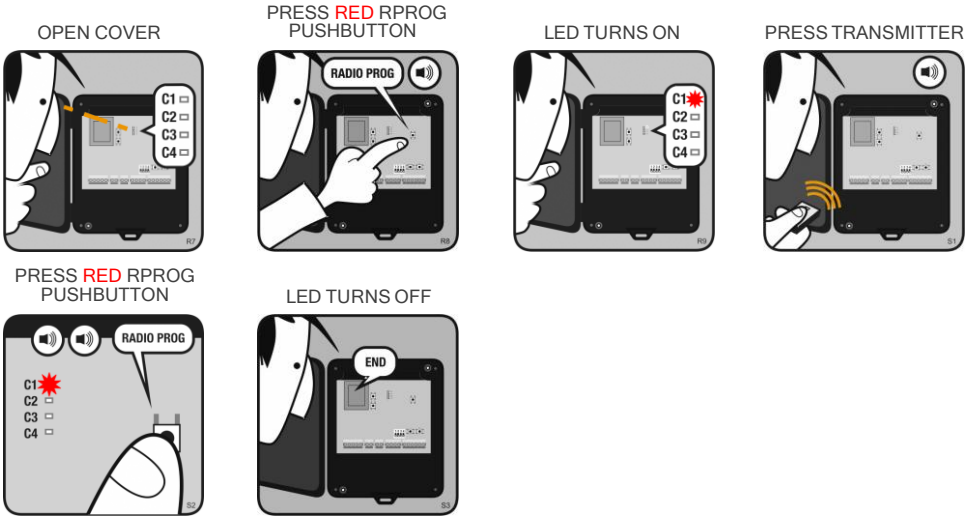

We recommend programming:

The top button of your MUV2-HP to C1 (START) for primary operation of the door.

The bottom button to C2 (DEADMAN CLOSE) to enable the door to be closed in deadman in an emergency such if there is a safety device issue.

NOTE: To program transmitters onto different channels, press and hold the red RADIO PROG pushbutton until the LED for that channel turns on, then release the RADIO PROG pushbutton and press the transmitter.

Total Reset

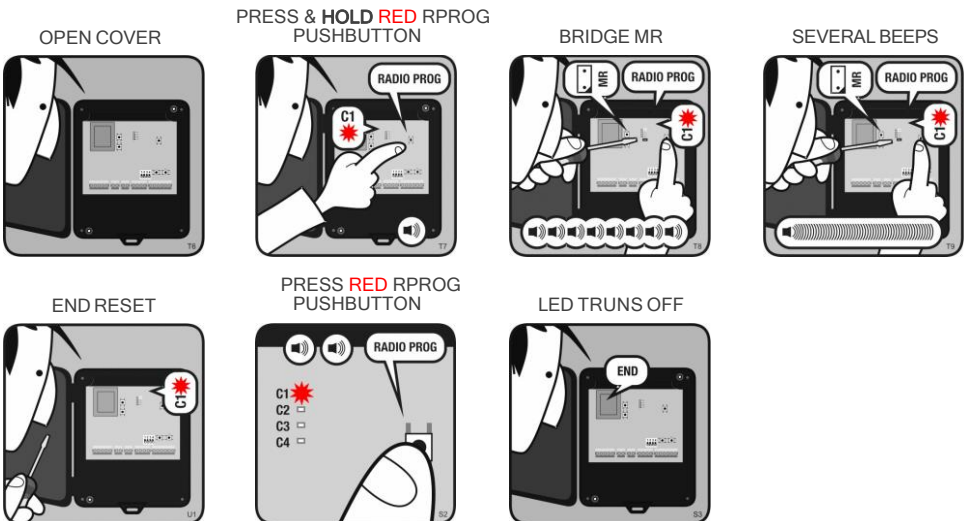

Safety devices programming

RadioBand3 Transmitter Programming in RSEC3 Receiver

Wire in the safety edge and set the dipswitches according to the RB3 TGL868 manual before programming.

PRESS **BLUE** PROG
BUTTON OF THE
PLUGGABLE CARD RSEC3

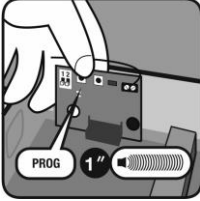

LED TURNS ON

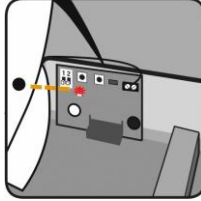

PRESS PROG
TRANSMITTER

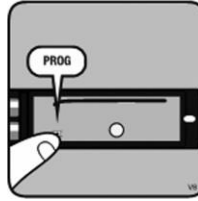

ONE BEEP AND
PROGRAMMED



PRESS **BLUE** PROG
BUTTON

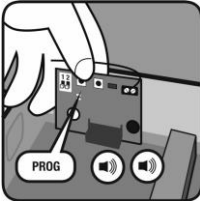

LED TURNS OFF AND
END PROG

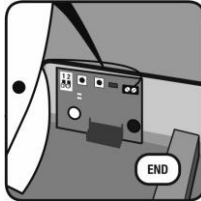

SLIDE THE COVER TO
CLOSE

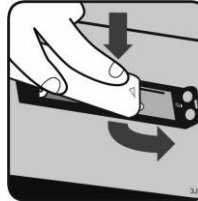

Maneuver programming

Programming the door maneuver

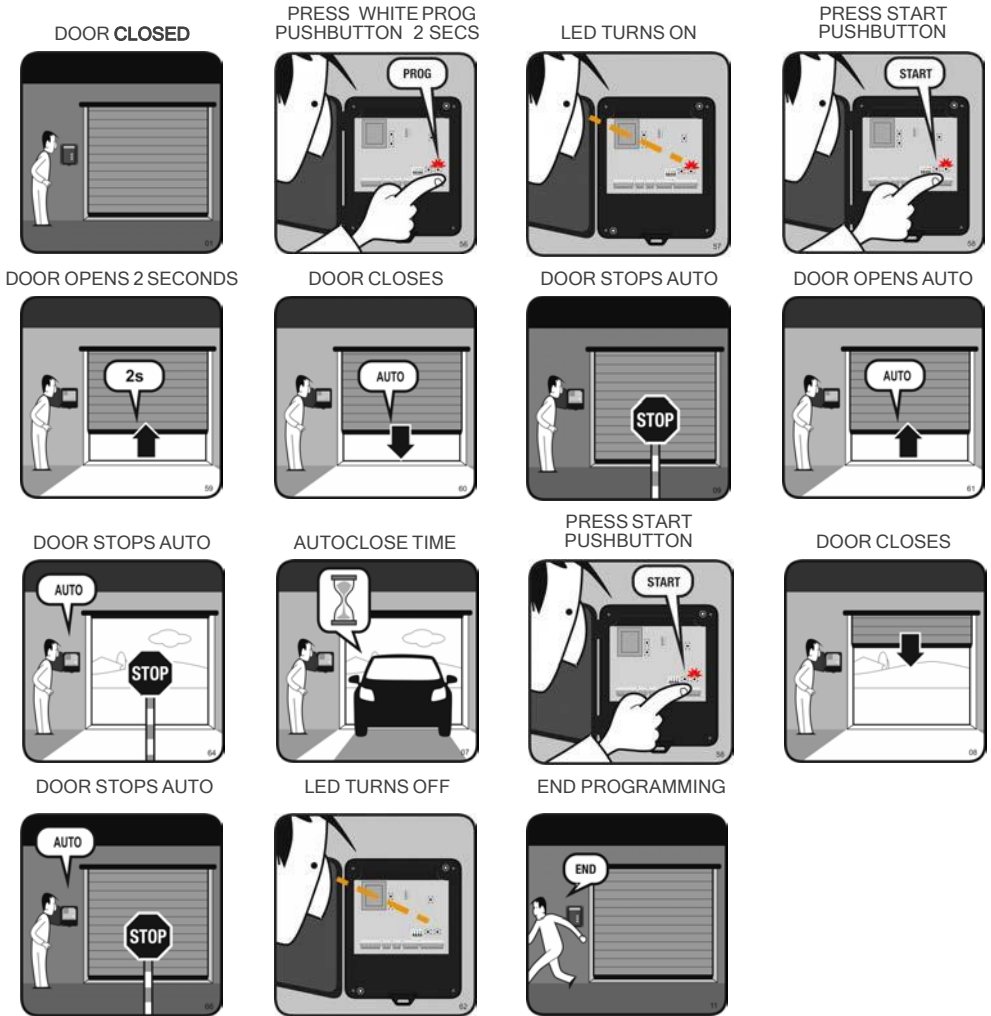

Inputs, outputs, dip-switches & radio inputs

Factory default settings. All the below can be modified with the VERSUS-PROG programming tool. If they are modified, please ensure this manual and the sticker on the inside of the control panel cover is updated.

For a full list of the settings & parameters available and their definitions, please refer to the VERSUS manual.

OUTPUTS		
OUT1	FLASH	
OUT2	COURTESY LIGHT LEVEL	
OUT19	AUTOTEST SIGNAL	
DIPSWITCH OPTIONS		
SW1	AUTOCLOSE	
SW2	DEADMAN	
SW3	PRE-FLASH	
SW4	SEC. CLOSE TEST	
INPUTS		
IN1	SEC. CLOSE AUTOTEST (NC)	
IN2	START (NO)	
IN3	STOP (NC)	
RADIO INPUTS		
IN31 (C1)	START RADIO SEC_DM	
IN32 (C2)	DEAD MAN CLOSE	
IN33 (C3)	OPEN	
IN34 (C4)	CLOSE	

Regulatory Data

EU Declaration of conformity

JCM Technologies hereby declares that the product **M8NF** complies with the relevant fundamental requirements of the RED Directive 2014/53/EU, as well as with the Machine Directive 2006/42/EC whenever its usage is foreseen; and with the 2011/65/EU RoHS Directive.

See website www.jcm-tech.com/declarations/

JCM TECHNOLOGIES, SA
C/COSTA D'EN PARATGE, 6B
08500 VIC (BARCELONA)
SPAIN

