



C Prox Ltd (Inc Quantek)

11 Callywhite Business Park, Callywhite Lane, Dronfield S18 2XP
+44(0)1246 417113 sales@cproxltd.com www.quantek.co.uk

CPWIFISW1

WiFi Smart Switch Manual



Features:

- Connects to home WiFi
- Turn devices on and off remotely through the App
- Manage numerous smart switches and other Tuya compatible smart devices from one App
- Compatible with Amazon Alexa, Google Assistant & Siri (via Shortcuts)
- Set schedules and timers
- Switch device on automatically when you get home (Beta)
- Share access with other users permanently or for a set time period
- Remove access to other users instantly
- Latching or timed mode
- Group device management
- Built in 433.92MHz receiver for remote controls

Specification:

- Input voltage: 7-32Vac/dc or 5V Micro-USB
- Max current load: 10A
- WiFi standard: 2.4GHz, 802.11 b/g/n
- Standby/max current draw: 80mA/115mA
- Dimensions: 73 x 46 x 30mm

Device setup

1. Download the 'Smart Life' App by searching in the mobile App stores or scanning the following QR codes.



Smart Life App

2. Create an account in the App, or if you already have an account just login.
3. Supply power to the WiFi switch and wire the relay output to the device you are controlling.

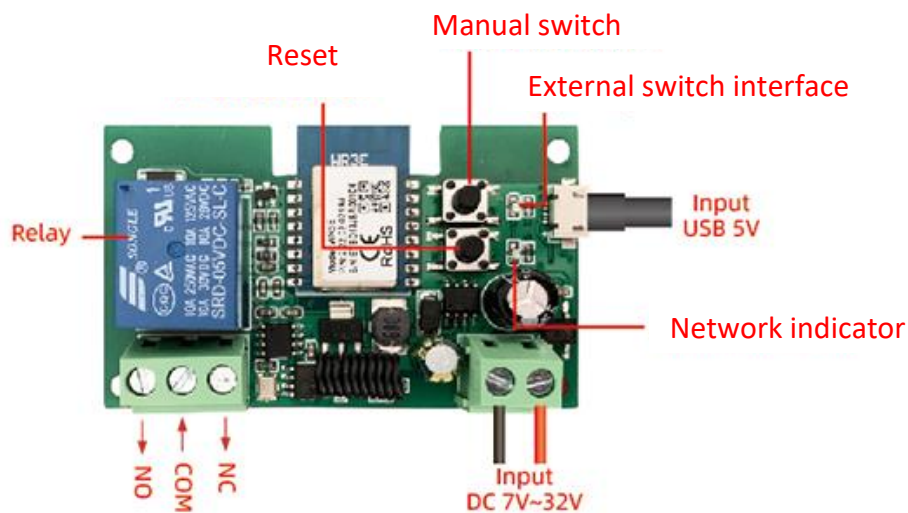

Wiring examples

Light

Set mode to latching

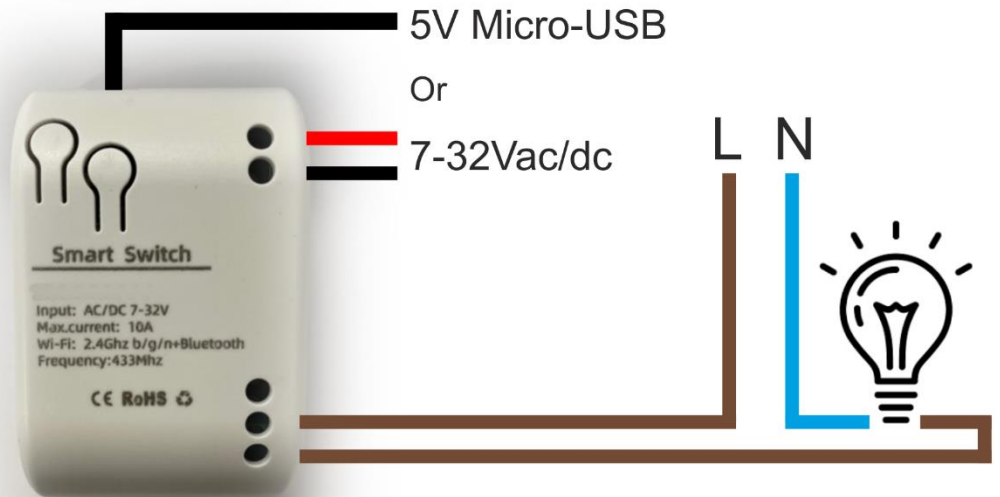

Gate

Set output to inching mode - 2 secs

Refer to gate panel manual for Start terminals

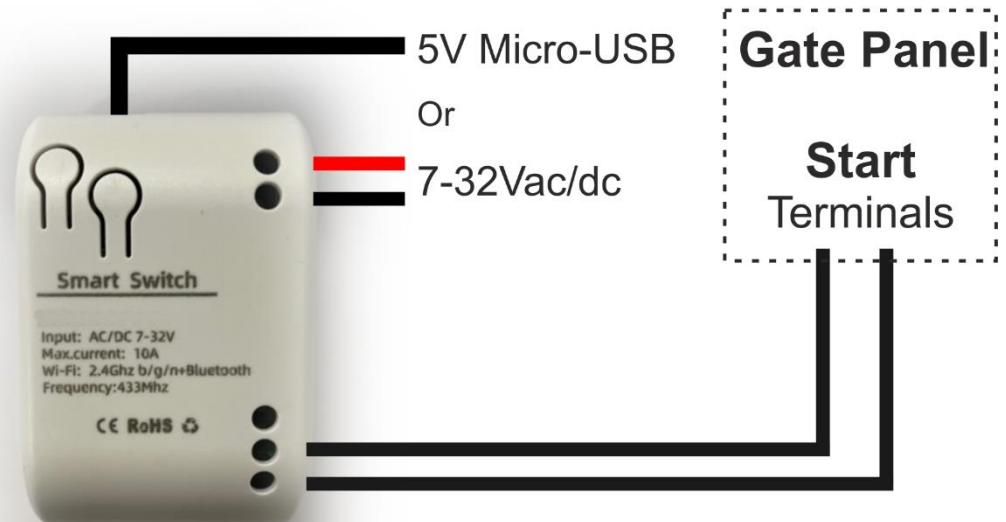

4. Power on the device.
5. Reset the device by pressing the reset button for 5 seconds until the red network LED indicator is flashing quickly every 0.5 seconds (if the network indicator is already flashing quickly, skip this step).

6. Add & connect the device in the App

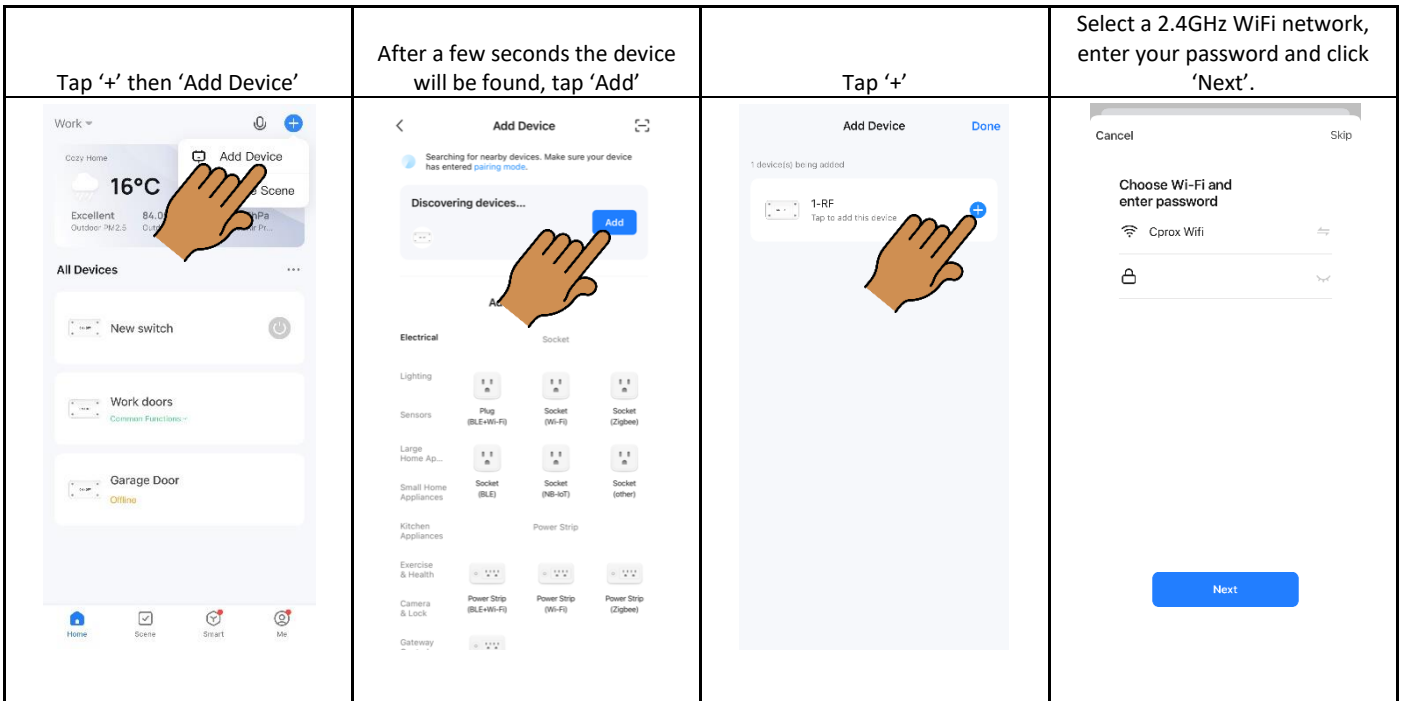

7. Name the device.

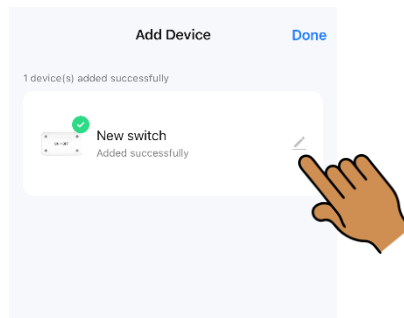

8. When the network is disconnected, the switch will automatically change to Bluetooth control from the phone. (Must be within range).

9. Click the On/Off button on the App to switch the relay and control the device.

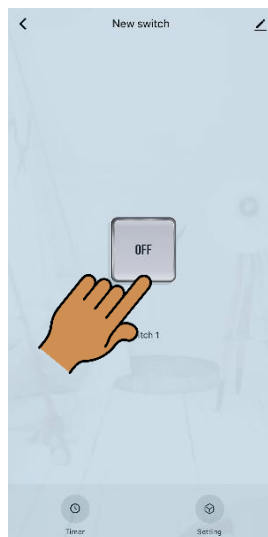

App functions



Tap here to enter function operation interface.

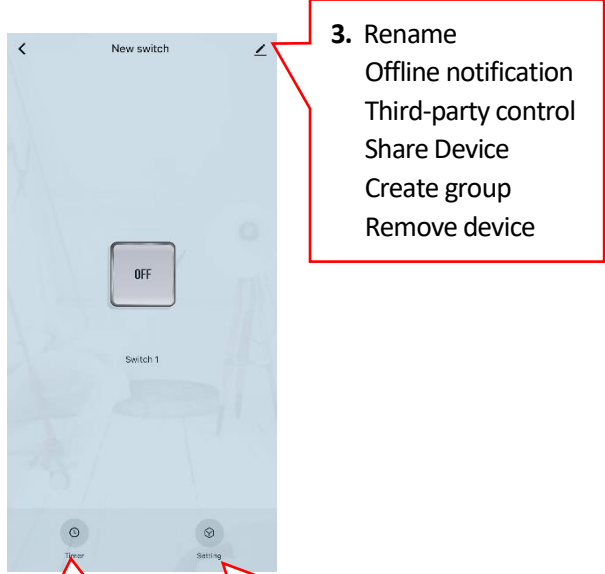

- 3. Rename
- Offline notification
- Third-party control
- Share Device
- Create group
- Remove device

- 1. Countdown
- Schedule
- Circulate
- Random
- Inching

- 2. Relay status
- RF remote control setup

1. Set the following:

Countdown (delay before the output activates)

Weekly schedules (up to 8 per device)

Circulate (set the device to switch on and off on a loop)

Random

Inching (set the output timed) Set to 2 seconds when connecting to a gate, door, garage, etc.

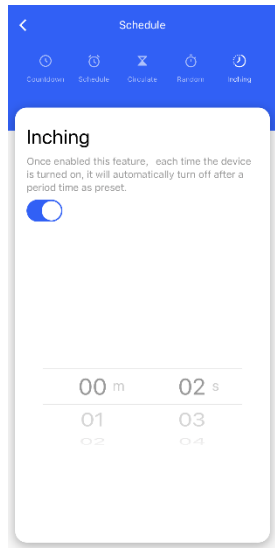
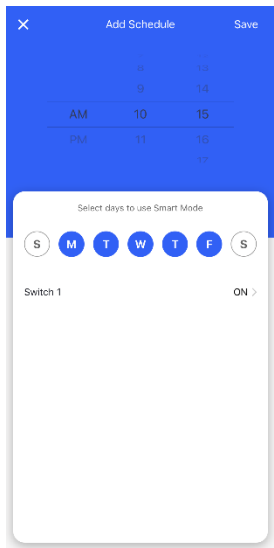
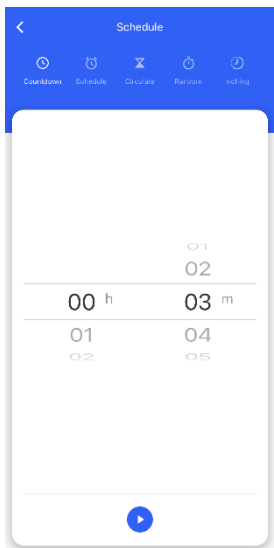

2. Set the following:

Relay status (when the device is switched back on after losing power)

RF remote control setup

Tap Add

When prompted, press the remote control button you want to add within 10 seconds

The message 'Add Success' will be displayed

To delete a remote control, swipe it to the left and tap delete

3. Edit device name & location.

Manage third party control, setup Alexa etc.

Share device with other users.

Create a group to control more than one device by a single tap.

Share device with other users

Other users must have a Smart Life account

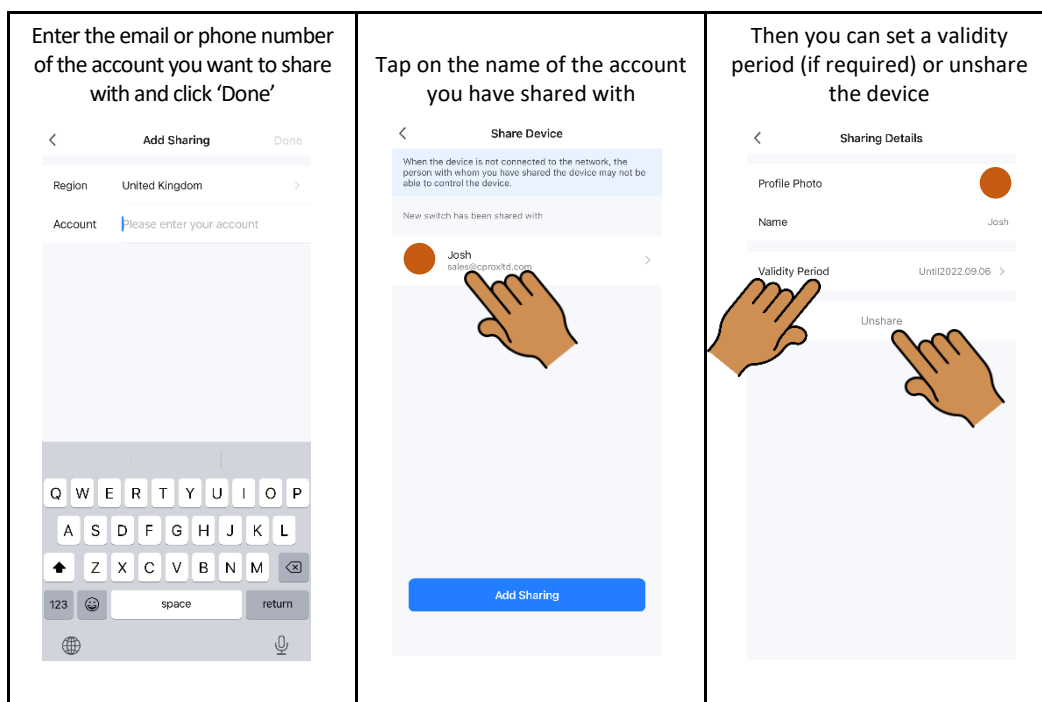
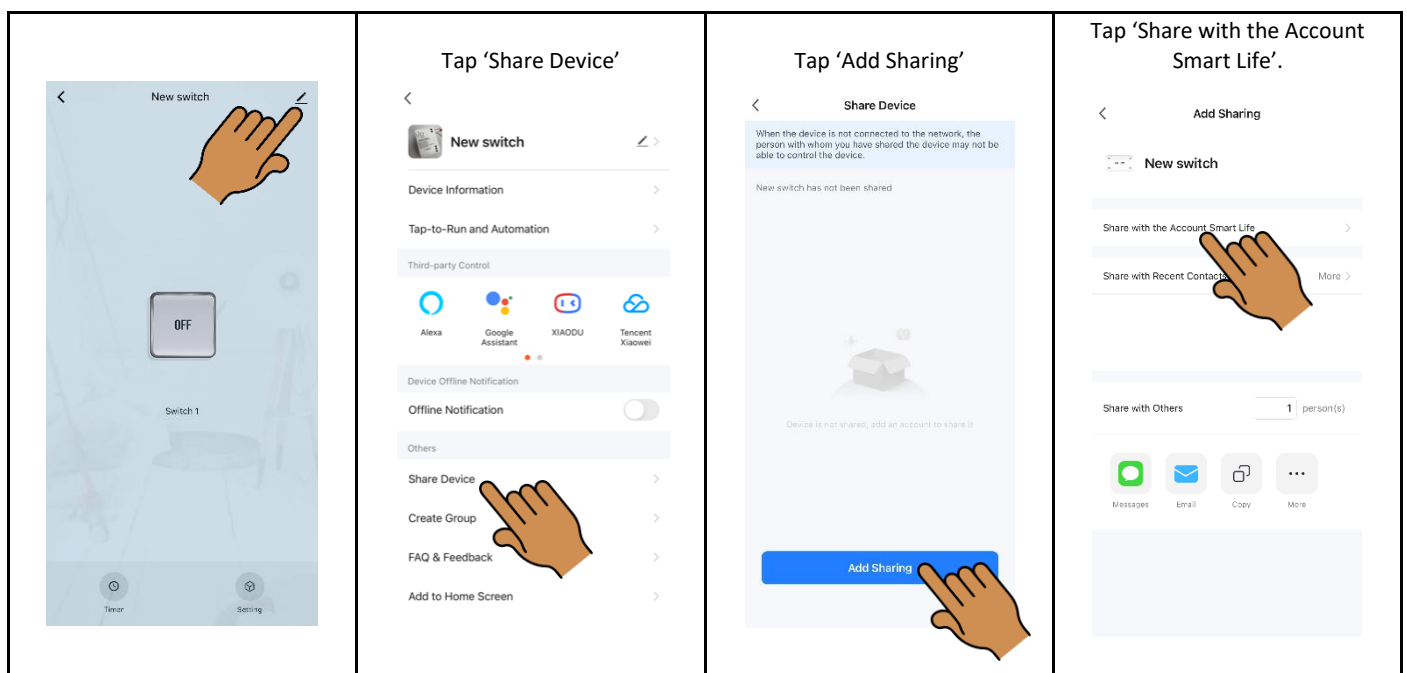

Create smart scenes and setup Siri

Tap 'Scene' then '+' or 'Create Scene'

Tap 'Launch Tap-to-Run'

Tap '+'

Tap 'Run the Device'

Select the appropriate switch

Select the name of switch again, select 'ON' and then tap 'Save' followed by 'Next'

Tap the 3 dots to rename the scene then tap 'Save'

Tap 'Add to Siri'

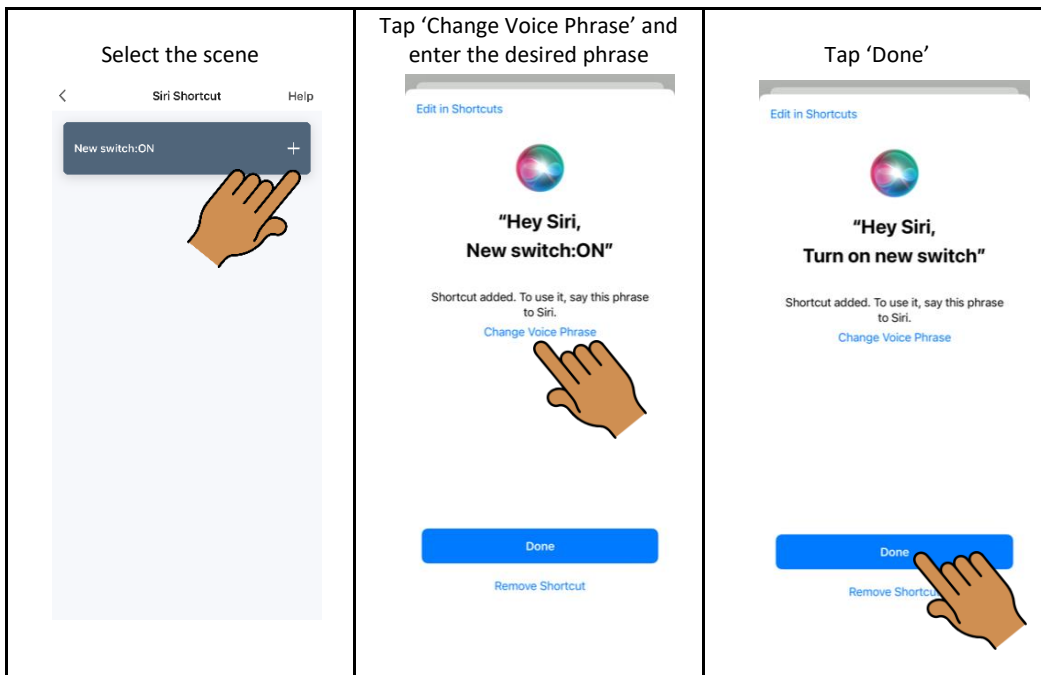

Please note, to use with Siri on other phones, you must share the 'Home' with other accounts, rather than just the device.

Tap 'Me' > 'Home Management' > Select the name of the Home > 'Add Member'

Please also make sure that the 'Shortcuts' App is downloaded on the phone.

Setup Alexa

The first panel shows the 'New switch' card in the Alexa app home screen. A hand icon points to the card. The second panel shows the 'New switch' control interface with an 'OFF' button and a hand icon pointing to it. The third panel shows the 'New switch' settings page, with a hand icon pointing to the 'Third-party Control' section. The fourth panel shows the 'Link Smart Life with Alexa' screen with a hand icon pointing to the 'LINK' button.

The first panel shows the 'DEVICES' screen with a hand icon pointing to the 'Devices' category. The second panel shows the 'ALL DEVICES' list with a hand icon pointing to 'New switch'. The third panel shows the 'NEW SWITCH' routine creation screen with a hand icon pointing to the 'Create a Routine' button. The fourth panel shows the 'ROUTINES' screen with a hand icon pointing to the '+' icon to create a new routine.

Name the routine. Then tap 'When this Happens'

Cancel NEW ROUTINE Save

NAME

Open Gate Change

When this happens
e.g. you say "Alexa, ..."

Add action
e.g. Play weather

Home Communicate Play **Devices** More

Tap 'Voice' and enter the desired voice command. Then tap 'Next'

< WHEN THIS HAPPENS

Voice

Schedule

Smart Home

Alarms

Sound Detection (public preview)

Home Communicate Play **Devices** More

Tap 'Add Action'

Cancel NEW ROUTINE Save

NAME

Open Gate Change

WHEN:

Alexa, Open gate
[View/Edit](#)

Add action
e.g. Play weather

Home Communicate Play **Devices** More

Tap 'Smart Home'

< ADD NEW

Customised
For more actions, type in what you would ask Alexa to do

Smart Home

Alexa Says

Audible

Calendar

Calling

Date and Time

Device Settings

Fire TV

Home Communicate Play **Devices** More

Tap 'All devices'

< SMART HOME

All Devices

Lights

Control scene

Home Communicate Play **Devices** More

Tap the name of the switch

< SELECT DEVICE

AVAILABLE

Front door

Garage Door

Light

New switch

Slider

TV

Work doors

Home Communicate Play **Devices** More

Tap 'Power – ON' then 'Next'

< NEW SWITCH Next

Power

On

Off

Home Communicate Play **Devices** More

Save your routine

Cancel NEW ROUTINE Save

NAME

Open gate Change

WHEN:

Alexa, Open gate
[View/Edit](#)

ALEXA,

Add action

New switch
Power: On

Home Communicate Play **Devices** More

Switch the device automatically when you get to a location

Please note this feature is a Beta service and requires location services to be on all the time.

<p>Tap 'Scene' then '+' or 'Create Scene'</p>	<p>Tap 'When location changes'.</p>	<p>Tap 'Arrive'.</p>	<p>Select location. Zoom in or out to adjust activation radius. Tap 'OK'.</p>
--	--	-----------------------------	--

<p>Tap '+'</p>	<p>Tap 'Run the Device'</p>	<p>Select the appropriate switch</p>	<p>Select the name of switch again, select 'ON' and then tap 'Save' followed by 'Next'</p>
-----------------------	------------------------------------	---	---

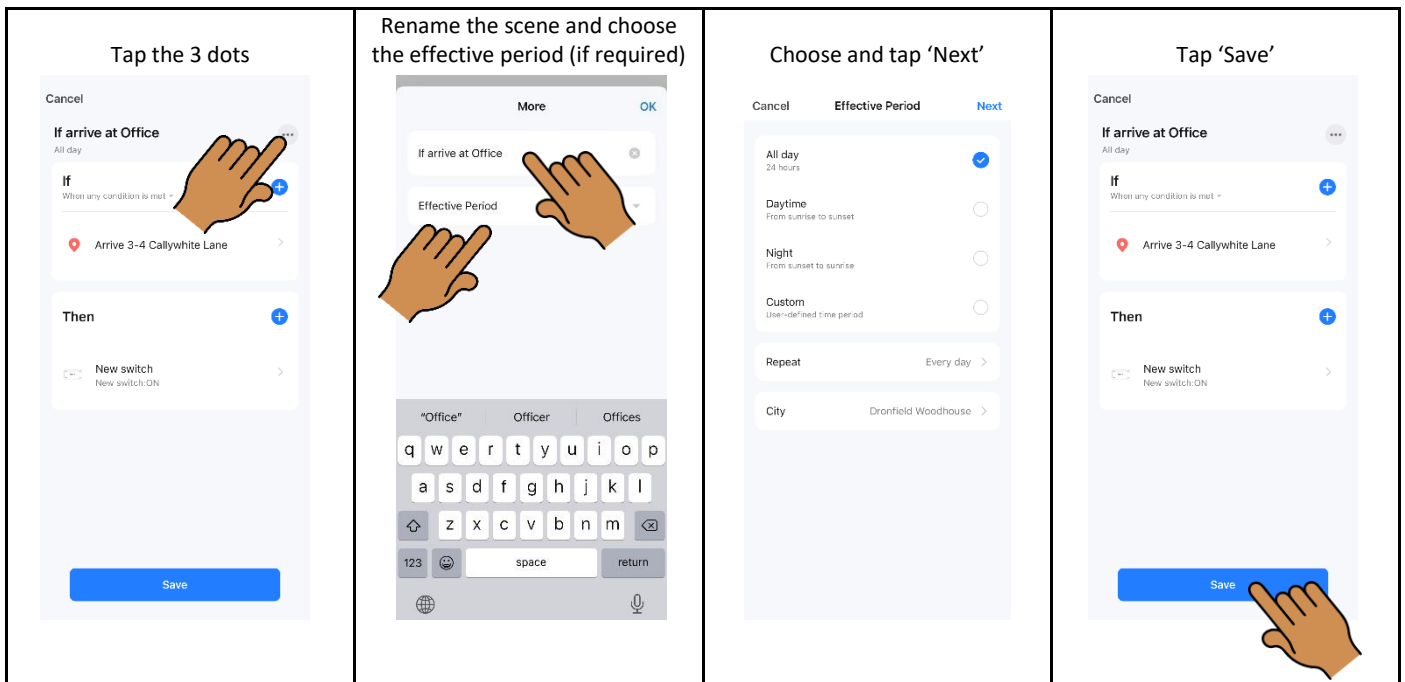

Troubleshooting

Fails to add device

- Double check the Wi-Fi password is correct.
- Reset the smart switch by pressing the reset button for 5 seconds. Tap Add device. If device is automatically discovered, cancel it being added automatically. Instead scroll down the list of devices, tap **Breaker(BLE+Wi-Fi)**. In the top right corner, you can choose Bluetooth or Wi-Fi mode. Try Bluetooth first, then Wi-Fi.

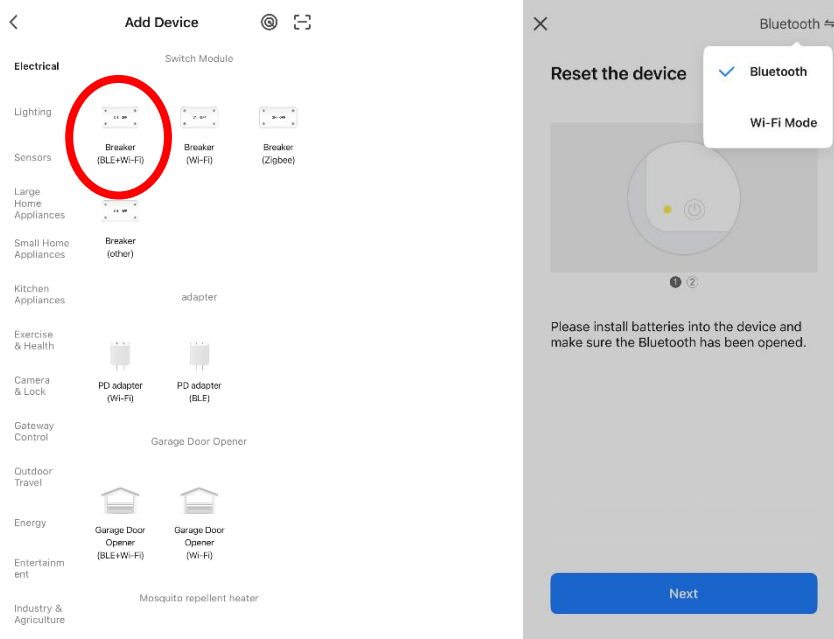

- Login to the router as administrator, turn off 5G (Wi-Fi switch only works on 2.4GHz) and repeat the adding process. Turn 5G back on after if successful.
- If problem persists, test on a different Wi-Fi network.

