



C Prox Ltd (Inc Quantek)

11 Callywhite Business Park, Callywhite Lane, Dronfield S18 2XP

+44(0)1246 417113 sales@cproxltd.com www.quantek.co.uk

SGMP3

Voice message announcer

A great addition to our disabled toilet locking systems. It warns the user that the door is opening, instructs & prompts them how to use the system and reassures them that the door is locked.

Other uses include auto door opening warning, vehicle moving warning, access control, queue control, shop announcement, etc.

Features

- Uses a high-quality MP3 decoder IC
- 8 trigger inputs available on the board. Plays different messages or music when triggered
- Mount on the wall or ceiling, surface or flush fit
- Update audio files easily via USB connection on computer
- Customise messages for different applications
- Supports 4 trigger modes to meet different applications
- Trigger mode can be set easily using a text file
- Adjustable sound volume through using the potentiometer
- White or black fascia and back box. Bespoke colours also available



Technical Parameters

- Working voltage: 6V to 30V DC
- Working current: $\leq 1000\text{mA}$
- Power consumption: $\leq 3\text{W}$
- Flash memory size: 4MB. Possible to load max. 4 minutes long MP3 file(s) of 128Kbps
- Sound pressure level: $\leq 90\text{dB}$
- 8ohm 2 watt high performance speaker
- Size 86 x 86 x 35
- Max 1.6mm precision terminal driver required

All units come pre-programmed for use with our disabled toilet locking systems.

All you need to do is connect it to the WCPCB as shown below.

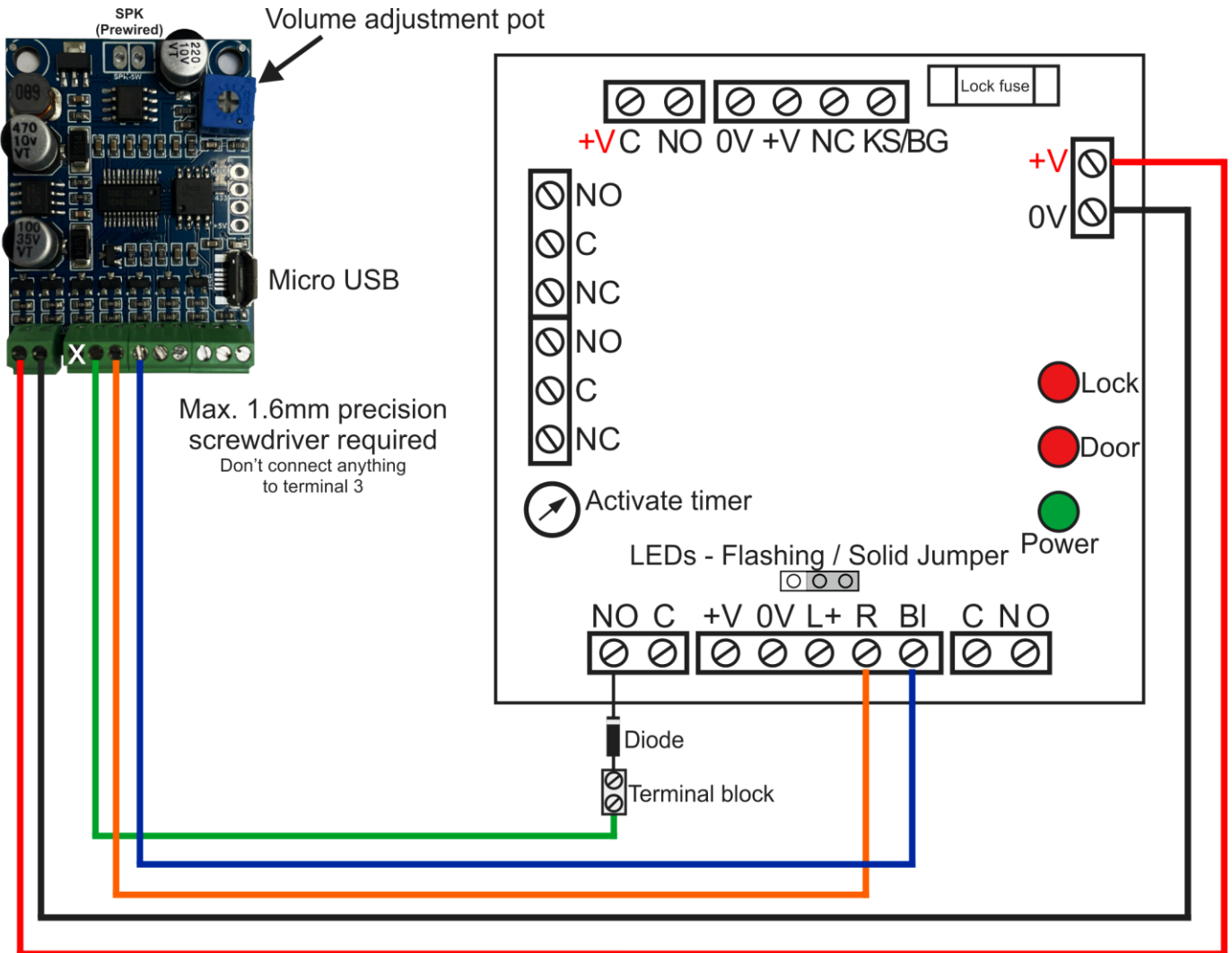

Default pre-programmed messages:

Activate the external sensor – “Caution door opening ... caution door opening ... when the door is shut, please touch the sensor to lock the door (repeated up to 3 times at 10 second intervals)”









Lock the door – “Door locked ... when finished, please touch the same sensor again to open the door (repeated up to 5 times at 10-minute intervals)”

Unlock door – “Door opening, please exit”

Programming

This step is only required if you have a different application to the disabled toilet locking system, or if you wish to modify the voice or messages.

1. Create your messages or music and save them in MP3 format.
2. Connect to a computer using a USB-A to Micro-USB cable (not supplied).
3. It will appear like a USB drive.

Name	Date modified	Type	Size
 001_Enter.mp3	25/08/2022 14:38	MP3 File	134 KB
 002_Locked.mp3	25/08/2022 14:38	MP3 File	3,108 KB
 003_Exit.mp3	28/09/2022 16:38	MP3 File	19 KB
 004.mp3	20/02/2014 04:29	MP3 File	15 KB
 005.mp3	20/02/2014 04:29	MP3 File	15 KB
 006.mp3	20/02/2014 04:28	MP3 File	14 KB
 007.mp3	22/04/2015 09:04	MP3 File	18 KB
 008.mp3	22/04/2015 09:04	MP3 File	14 KB
 Config.txt	11/10/2024 15:36	Text Document	1 KB

4. Delete the .mp3 files and replace them with your own.
5. Name them as shown above. File 001 plays when Input 1 is triggered. File 002 plays when Input is triggered. File 003 plays when Input 3 is triggered. You can add _description after the number in the file name to help identify them.
6. Change the mode within the Config.txt file if required (see next page for more information).
7. Right click on USB Drive(X:) and click Eject.

Trigger Mode Selection

To change the mode, change the number in the 'Config.txt' file.

Number in Config File	Explanation
1	The audio file will only play back while input is maintained. During playback if the input is released, the playback will stop. If the input is maintained, when the playback of the audio file is finished, it will start to play it repeatedly (loop playback).
2	The audio file will only play back while input is maintained. During playback if the input is released, the playback will stop. If the input is maintained, when the playback of the audio file is finished, it will stop.
3 Default	Pulse the input to start playback. It is possible to interrupt the playback by triggering the same input used to activate. Once playback is interrupted, it will automatically restart the audio file immediately. It's also possible to interrupt the playback by triggering the other inputs. Once playback is interrupted, it will automatically start the sound that is associated with that input.
4	Pulse the input to start playback. It's not possible to interrupt the playback by pressing the same button or the other buttons. Once an audio file is triggered, the audio file will not be able to be interrupted/cancelled during playback. The playback will only end when the audio file has played its entirety.

Other application wiring

