



jcmtechnologies



user manual

I20EU



Index

Index.....	2
Safety instructions – Important annex.....	3
Important safety instructions for the installation.....	3
Important safety instructions for use.....	4
1. Introduction.....	5
2. Technical Data.....	5
3. Description.....	6
4. Installation.....	8
5. Connections.....	9
5.1 Power supply connection.....	9
5.2 Motor connection.....	9
5.3 Input connection.....	10
5.4 Output connection.....	10
5.5 Option selector.....	11
6. Programming.....	12
6.1 Checking motor direction.....	12
6.2 Manoeuvre programming with digital end limit switch (ENCODER).....	12
6.3 Fine adjustment (for programming with absolute encoder).....	13
6.4 Manoeuvre programming with limit switches.....	14
6.5 Partial manoeuvre programming.....	14
7. Maintenance.....	15
7.1 Is it working?.....	15
7.2 Indicator light for possible faults in the panel cover.....	15
7.3 Indicator light for possible faults, LED ERROR.....	15
Using the equipment.....	16
EU Declaration of Conformity.....	16

Safety instructions – Important annex



Important safety instructions for the installation

- Disconnect the power supply before manipulating the equipment in any way.
- Before installing the panel, remove all unnecessary ropes or chains and disable any equipment such as locks that is not necessary for the automatic operation.
- Before installing the panel, check that the door is in good mechanical condition, correctly balanced and that it opens and closes correctly.
- Install the manual unlocking device at a height lower than 1.8m.
- Install any permanent control next to the door away from any moving part and at a minimum height of 1.5m.
- An easily accessible power supply disconnection device must be fitted to the wiring for permanently connected equipment. This device must ensure multi-pole cut-off of the power supply. It is advisable for this to be an emergency breaker/isolator type switch.
- If the panel is supplied without an emergency stop button, this must be incorporated into the installation, connecting it to the STOP terminal.
- For correct use of the security band, this must never be activated when the door is fully closed. It is recommended to install the limit switches before activating the band.
- This equipment can only be manipulated by a specialist fitter, by maintenance staff or by a suitably trained operator.
- To connect the power supply and motor wiring, terminals with a cross-section of 2.5 mm² must be used.
- Use protective eyewear for handling the equipment.
- Fuses must only be handled when the appliance is disconnected from the power supply.
- The instructions for using this equipment must remain in the possession of the user at all times.
- European door standard EN 12453 and EN 12445 specify the following minimum protection and safety levels in doors:
 - for single-family homes, prevent the door being able to come into contact with any object or limit the contact force (e.g. safety edge), and, in the event of automatic closure, a presence detector (e.g. photocell) must be added.
 - for communal and public installations, prevent the door being able to come into contact with any object or limit the contact force (e.g. safety edge) and detect presence (e.g. photocell).

I20EU control panel switches automatically to dead man mode when safety devices are active or defective. Therefore, all controls work as “hold-to-run” controls.



WARNING: IN ACCORDANCE WITH THE EN 13241-1 AND EN 12453-1 STANDARD CONCERNING PRESSURE MAINTAINED CONTROL DEVICES:



- “The person operating the door must have a direct view of the doorway, must be near the door (5 meters maximum) during movement of the door and should not find itself in a dangerous position”.
Any adjustment of the radio range out of these recommendations, undertakes the installer in terms of responsibility for injury or damage.
- “Releasing of the pressure maintained control device should stop the door movement before it scrolls 5cm!”.

Important safety instructions for use

- Do not allow children to play with the door controls.
- Keep the remote controls out of the reach of children.
- Watch the door movement and keep people away until the door is fully open or closed.
- Take care when operating the manual unlocking device, as the door may suddenly fall due to the bad condition of the springs or a poorly balanced door. Details on how to use the manual unlocking device must be provided by the manufacturer or the device installer.
- Examine the installation frequently, especially the cables, springs and supports, to detect signs of wear, damage or imbalance. Do not use the door if it needs to be repaired or adjusted, as doing so may cause injury.

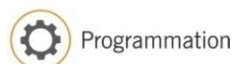

1. Introduction

A three-phase control panel with position control using Elektromaten or Kostal digital end limit switches or mechanical limit switches, designed for high speed doors.

Fitted with motor brake and flashing outputs at 230v AC, and voltage-free contact outputs for indicating door open and door closed.

Fitted with one 24Vac and two 24Vdc power supply outputs for connecting photocells or other accessories such as radar. Between the three of them, these outputs provide a maximum of 700mA.

It has inputs for opening and closing buttons, as well as for selecting total or partial opening. It also has inputs for limit switches, security contacts, safety edge and stop button.

It also has connectors for plug-in cards: motion STICK receiver, radioband3G RSEC3 receiver, traffic light card TL-CARD-V and magnetic detector card MTC1.

In case of activation of any safety input, if any control input is kept active, the movement of the door will pass to a hold-to-run control mode (Dead Man), and the LED on the cover will flash to indicate that mode.

This control panel complies with current electrical safety standard EN 60335-1: 2012.

2. Technical Data

PARAMETER	VALUE
Power supply	400Vac three-phase / 230Vac
Maximum power of motor	2,2kW / 1,2kW
Optional cards (EXPANSION1/EXPANSION2)	RSEC3, TL-CARD-V
Receiver card connector	Motion STICK / DCS RACK
230V output	Motor brake and flashing
Voltage-free outputs	OPEN/CLOSE door status signals
24Vac +/- 20% / 24Vdc / 24Vdc TEST outputs	Accessories power supply / Photocells test (shared 700mA)
ENCODER connector	Connector for digital end limit switch with encoder inhibiting selector
Auto-close time	Adjustement from 3s to 60s,
Operating temperature	-20°C a +55°C
IP rating	IP65
Size	285 x 225 x 92 mm

3. Description

1- EXPANSION CARD 1

RSEC3 Radioband receiver connector

2- EXPANSION CARD 2

TL-CARD-V Connector

3- RECEIVER

Motion STICK / DCS RACK receiver connector

4- 24VAC OUTPUT

Output for power supply for accessories

5- FUSE

1A/250V

6- SELECTION 400VAC / 230VAC

7- POWER SUPPLY

Power supply input connection

8- LEDS ON / ERROR

Indicates power supply / error

9- PANEL DIRECTION LEDS

Indicate motor turning direction

10- MTC

Connector for magnetic detector card MTC1

11- NEUTRAL

Connection for neutral

12- PROTECTION EARTH

Connection for earth

13- MOTOR

Connection for motor U (Open) V (Close)
W (Common)

14- MOTOR BRAKE

Connection for 230Vac motor brake

15- FLASH LAMP

Connection for 230Vac flash lamp

16- CLOSED

Voltage-free contact (indicates door closed)

17- OPEN

Voltage-free contact (indicates door opened)

18- EMERGENCY

Cover emergency pushbutton.

19- ENCODER

Connector for Elektromaten/Kostal end limit switches

20- ABS.ENC SAFETY CHAIN

Jumper on right position inhibits the security inputs from the digital end limit switch.

21- PUSHBUTTON INPUTS

Connection for external buttons (Partial opening, Opening and Closing)

22- LIMIT SWITCH INPUTS

Connection for mechanical limit switches (Opening and Closing)

23- SAFETY EDGE / STOP INPUTS

Connection for 8k2 band / Stop pushbutton

24- SAFETY CONTACT INPUTS

Connection for photocells (Open and Close)

25- 24VDC OUTPUT

Fixed output 700mA, shared with all 24v outputs

26- 24VDC OUTPUT / TEST

Output for photocell tests, 700mA shared with all 24v outputs

27- PROGRAMMING PUSHBUTTONS

Open and close manoeuvre programming

28- REMOTE CONNECTOR

Connection for VERSUS-PROG programmer

29- AUTOCLOSING TIME

Min=3s - Max=60s

Maximum position=No auto-close

30- SELECTORS - OPTIONS

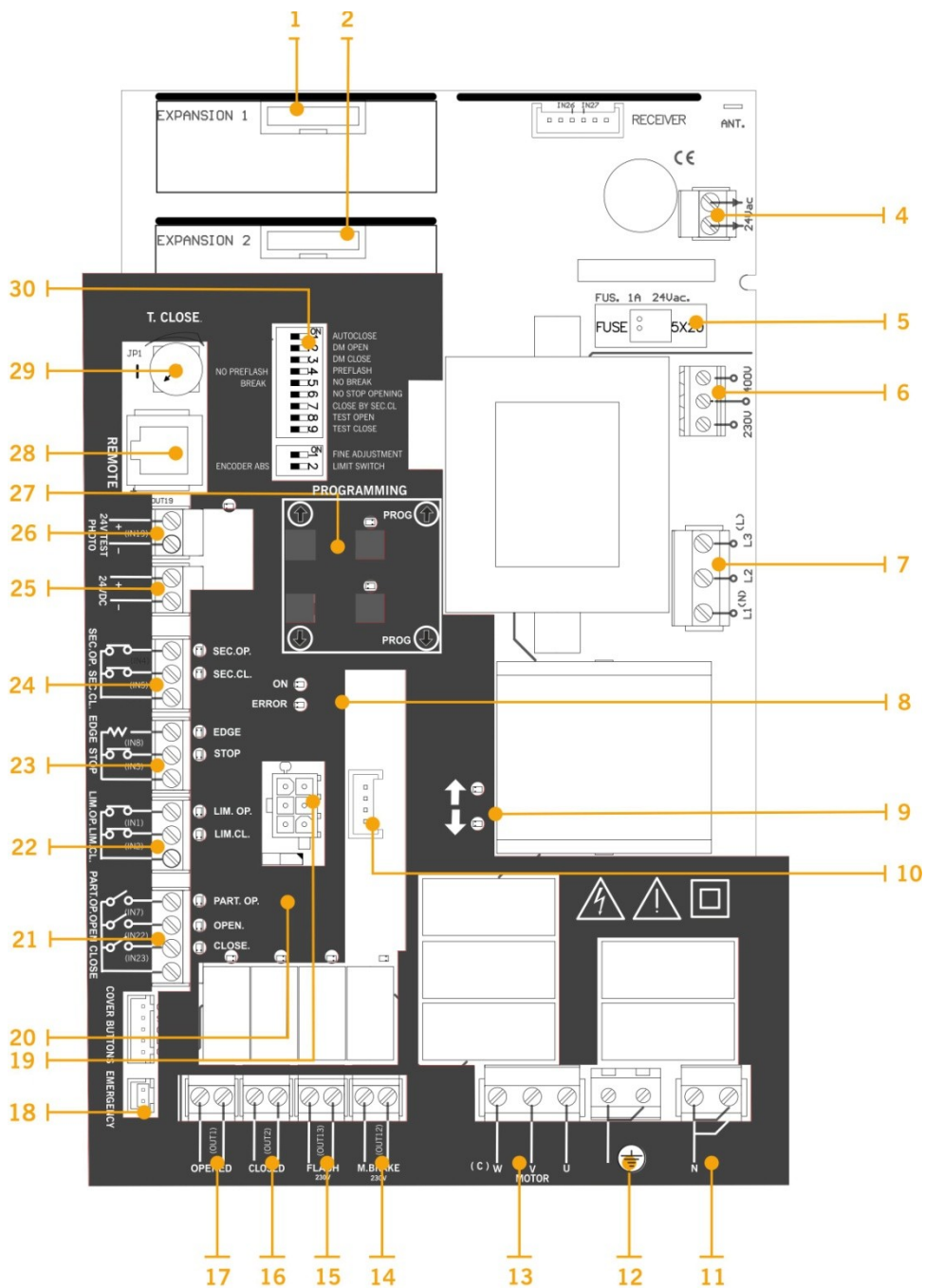

4. Installation



Install the control panel vertically on the wall at a height of 1.5m and following the assembly instructions.

UNSCREW

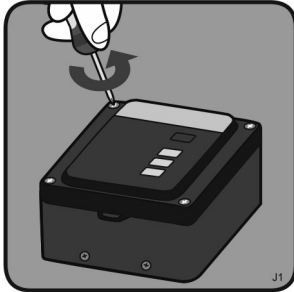

OPEN TOP

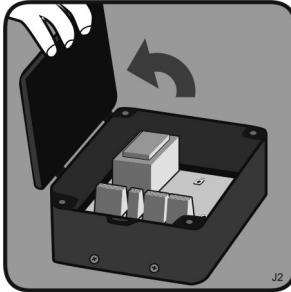

DRILL WALL

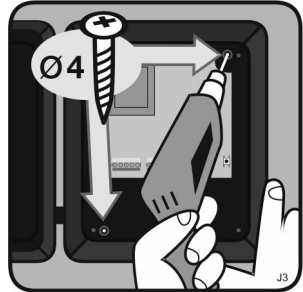



5. Connections

5.1 Power supply connection

POWER SUPPLY 230V SINGLE PHASE

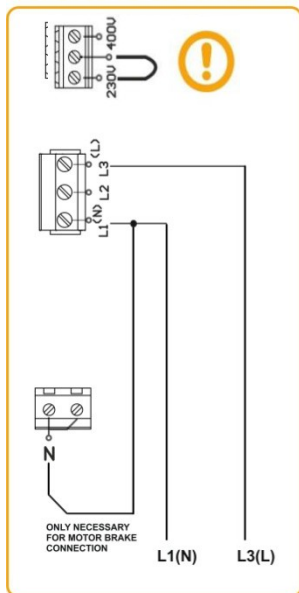

POWER SUPPLY 230V THREE PHASE

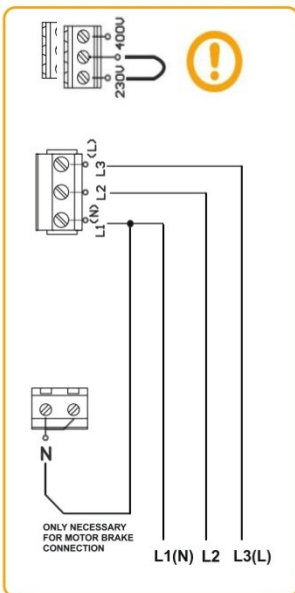

POWER SUPPLY 400V THREE PHASE

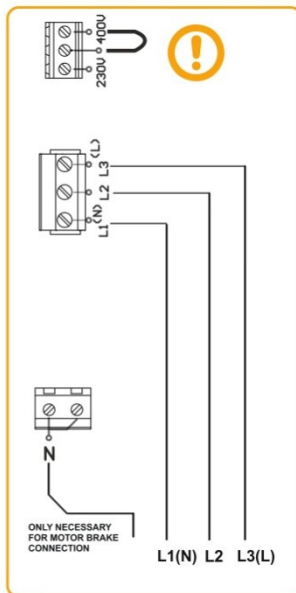

5.2 Motor connection

230V MONOPHASE MOTOR

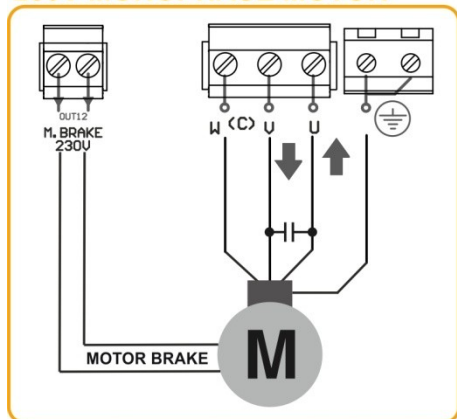

THREE-PHASE MOTOR

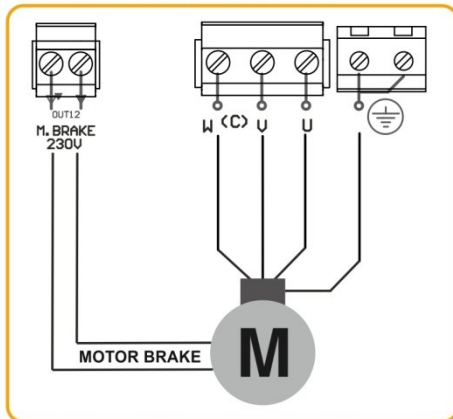

5.3 Input connection

PHOTOCELL INPUT

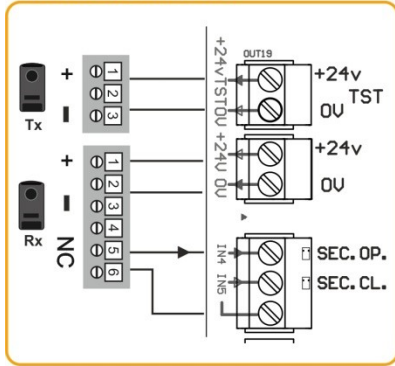

SAFETY EDGE / STOP INPUTS

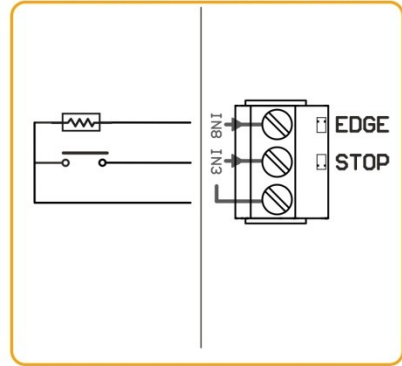

LIMIT SWITCHES INPUTS

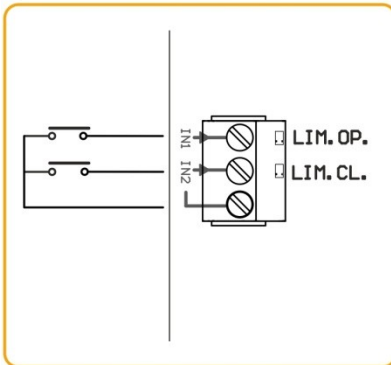

PUSHBUTTONS INPUTS

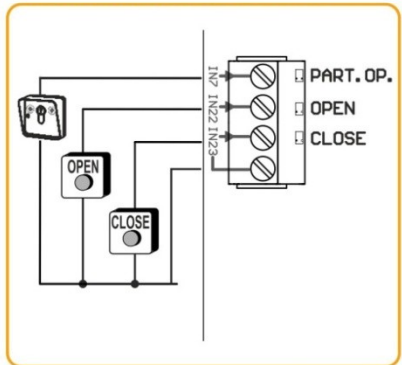

OPTO SAFETY EDGE INPUT

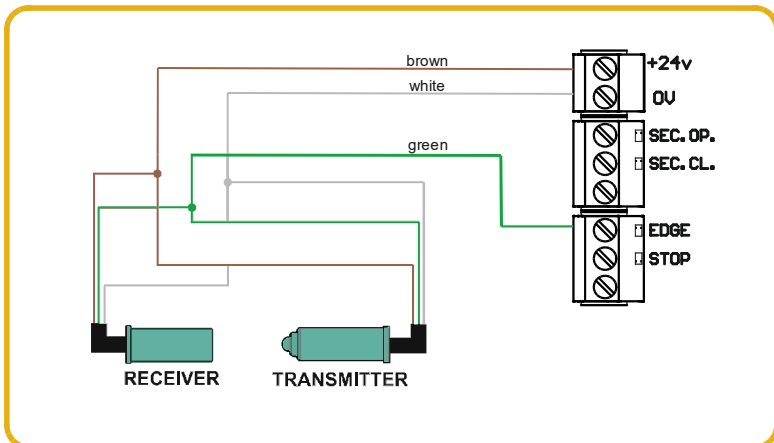

GridScan/PRO PHOTOCELL BARRIERS (FSS)

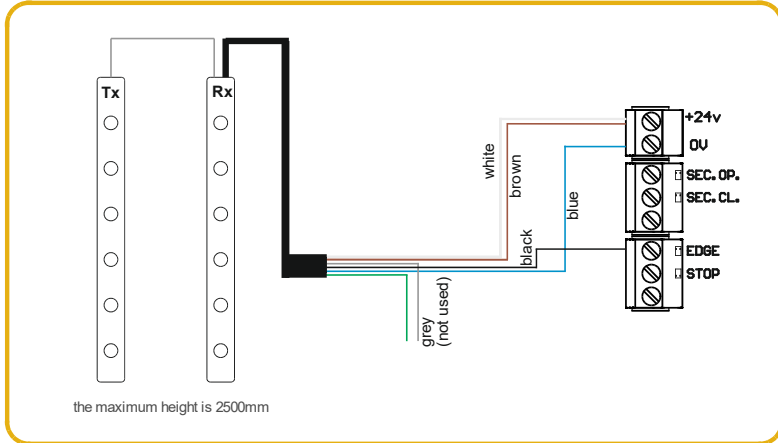



5.4 Output connection

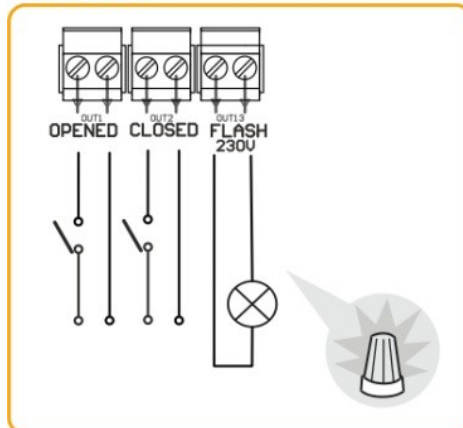

OUTPUTS

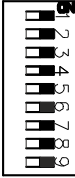

5.5 Option selector

By default all selectors leave the factory set to OFF.

 OFF ←	SELECTOR OPTIONS	ON → 
Do not closes automatically	1- AUTOCLOSE	Closes automatically
Functioning without dead man on opening	2- DM OPEN	Activates the dead man on opening manoeuvre
Functioning without dead man on closing	3- DM CLOSE	Activates the dead man on closing manoeuvre
Without pre-flash	4- NO PREFLASH / PREFLASH	Activates the pre-flash function
Activates motor brake function	5- BREAK / NO BREAK	Deactivates motor brake function
Start button performs an stop at opening	6- NO STOP ON OPENING	Start button opens until total opening
Deactivates closing by security contact	7- CLOSE BY SEC.CL.	Activates closing by security contact
Does not perform auto-test of the opening security contact	8- TEST OP	Activates the opening security contact auto-test.
Does not perform auto-test of the closing security contact	9- TEST CL	Activates the closing security contact auto-test.

 OFF ←	SELECTOR OPTIONS	ON → 
Deactivates the fine adjustment function	1- FINE ADJ	Activates the fine adjustment function (only functioning with digital end limit switches)
Activates functioning by digital end limit switches connector (ENCODER connector)	2- ENCODER ABS/ LIMIT SWITCH	Activates functioning by mechanical limit switches input



6. Programming

Before powering up the panel, leave the door in half way.

Power up the control panel and proceed to program it.

When programming, it is preferable to make medium and/or long runs to short ones (in order to improve hysteresis and inertia).

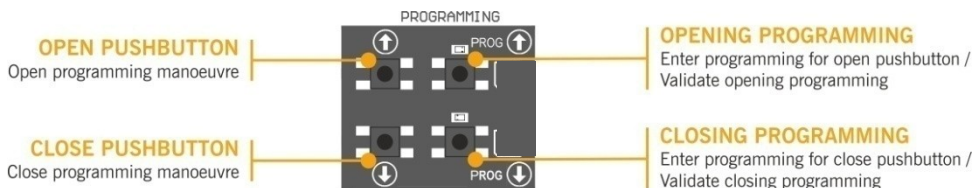



6.1 Checking motor direction





1. Turn the Options 2 selector to the ON position
2. Press the Open button on the cover and check that the door opens.
3. If it fails to open, disconnect the power supply and swap over the wires to the motor.

6.2 Manoeuvre programming with digital end limit switch (ENCODER).





Turn the Options 2 of the Options 2 selector to the OFF position

Only the buttons   on the board can be used, and these will function in dead man mode.

PROGRAMMING FOR OPENING

1. Press the **PROG**  button for 3 seconds, the indicator light will come on.
2. Position the door in the door open point using the buttons  . It is advisable to make long runs in order to ensure a correct adjustment.
3. Once the door is in the desired “door opened” position, press the **PROG**  button to validate the “door opened” position. The indicator light will flash a number of times and then go out.

PROGRAMMING FOR CLOSING





1. Press the **PROG**  button for 3 seconds, the indicator light will come on.
2. Position the door in the door closed point using the buttons  . It is advisable to make long runs in order to ensure a correct adjustment.
4. Once the door is in the desired “door closed” position, press the **PROG**  button to validate the “door closed” position. The indicator light will flash a number of times and then go out.

6.3 Fine adjustment (for programming with absolute encoder)





Once the manoeuvre has been programmed, a fine adjustment of the programmed “door open” and “door closed” position can be made.

Situate Option 1 of the Options 2 selector in the ON position. The indicator lights will flash continually. Door is not moved with this selector in ON position.

MODIFYING THE “DOOR OPENED” POSITION

1. Press the **PROG**  button. The indicator light will come on.
2. Press the  or  button to increase or decrease the “door open” position. Each press will be approximately equivalent to 1 cm (this value depends on the absolute encoder resolution).
3. Once the “door opened” position has been adjusted, press the **PROG**  button to validate the “door opened” position. The indicator light will flash a number of times and then go out.

MODIFYING THE “DOOR CLOSED” POSITION

1. Press the **PROG**  button. The indicator light will come on.
2. Press the  or  button to increase or decrease the “door closed” position. Each press will be approximately equivalent to 1 cm (this value depends on the absolute encoder resolution).
3. Once the “door closed” position has been adjusted, press the **PROG**  button to validate the “door closed” position. The indicator light will flash a number of times and then go out.



Situate Option 1 of the Options 2 selector in the OFF position. The indicator lights will turn off.

6.4 Manoeuvre programming with limit switches



Turn the Options 2 of the Options 2 selector to the ON position

The limit switches need to be adjusted before programming, and the door positioned in the “door closed” position.

PROGRAMMING FOR OPENING

1. Press the **PROG**  button for 3 seconds. The indicator light will come on.
2. Press the Open button . The door will open automatically until it encounters the opening limit switch.

PROGRAMMING FOR CLOSING

3. Press the **PROG**  button for 3 seconds. The indicator light will come on.
4. Press the Open button . The door will close automatically until it encounters the closing limit switch
5. End of programming, the indicator light will flash a number of times and then go out.

6.5 Partial manoeuvre programming

Bridge the Partial opening input IN7 and proceeds to programme according to 6.2 or 6.4 as desired.

In this case, the “door opened” position will be located at the half way point of the run



7. Maintenance







7.1 Is it working?

Once the control panel has been installed, check that all the system is working correctly.

7.2 Indicator light for possible faults in the panel cover

STATUS	INDICATION	SOLUTION
On continuously	The panel is powered up	---
1 flash every 3 secs	Error or activation of Radioband/safety edge	Check that no obstacle has been detected and check the safety device connection
2 flashes every 3 secs	Error or activation of Close Photocell	Check that no obstacle has been detected and check the safety device connection
3 flashes every 3 secs	Error or activation of Open photocell	Check that no obstacle has been detected and check the safety device connection
4 flashes every 3 secs	Absolute encoder error	Check the absolute encoder connection
Continuous flashing	Emergency stop or Stop activated	Check that the STOP input has been activated

7.3 Indicator light for possible faults, LED ERROR

	ERROR	LED ERROR	INDICATION	SOLUTION
 02	INTERNAL ERROR	10 slow flashes 2 quick flashes	Internal error	Consult the technical service
 09	MAX. PROG. TIME	10 slow flashes 9 quick flashes	The maximum permitted programming time has been exceeded	Program a shorter time manoeuvre than the maximum permitted
 12	CLOSING BAND ERROR	1 slow flashes 2 quick flashes	Closing safety band error	Check the closing safety band connections
 13	OPENING BAND ERROR	1 slow flashes 3 quick flashes	Opening safety band error	Check the opening safety band connections
 19	CLOSE TEST ERROR	1 slow flashes 9 quick flashes	Closing safety contact autotest error	Check that the device connected to the closing safety contact is in good condition and correctly installed
 6	STOP	2 slow flashes 6 quick flashes	The panel has stopped due to a STOP or due to an activated encoder STOP	Check that the STOP input has been to a STOP or due to an activated encoder STOP
 0	RBAND DOES NOT EXIST	3 slow flashes 10 quick flashes	The panel had been programmed with RBAND and it is no longer there	Re-program the panel without RBAND or connect the RBAND with which the panel had been

		programmed		
1	RBAND NC IN PROG	3 slow flashes 1 quick flashes	The panel has not been programmed with RSEC3 connected	Re-program the panel with the RSEC3 RSEC3 card connected
2	FC NOT LEARN	3 slow flashes 2 quick flashes	Error in limit learning	Check the motor's internal limit switches
9	PANEL LOCKED	3 slow flashes 9 quick flashes	An attempt has been made to enter programming with the panel locked	Enter the password with the V-DPLAY or VERSUS-PROG to unlock the control panel
41	ENCODER ERROR	4 slow flashes 1 quick flashes	No absolute encoder found or the encoder itself is returning an error	Check absolute encoder connection.



In case of any safety error, the door can be moved keeping pressed the  or buttons or any other input controls.

Using the equipment

Designed for the automation of rapid flexible doors in accordance with the general description. Not guaranteed for other uses.

The manufacturer reserves the right to alter equipment specifications without prior notification.

EC Declaration of Conformity

JCM TECHNOLOGIES, SA hereby declares that the product **I20EU** complies with the relevant fundamental requirements of the Machine Directive 2006/42/EC as well as with the Directives 2014/30/EU on electromagnetic compatibility and 2014/35/EU regarding low voltage whenever its usage is foreseen; and with the 2011/65/EU RoHS Directive.

See website www.jcm-tech.com/en/declarations

JCM TECHNOLOGIES, SA • C/COSTA D'EN PARATGE, 6 - 08500 VIC (BARCELONA) SPAIN



