



KEEroll

User Manual

Table of contents

Important safety instructions	4
Safety instructions for installation	4
Safety instructions for the use	5
Use of the equipment	5
Introduction	6
KEEroll	6
<i>Indicators</i>	6
<i>Actions</i>	7
RadioSens3 System	8
<i>Battery life</i>	8
.....	9
KEEpad & KEEpush	10
<i>KEEpad</i>	10
<i>KEEpush</i>	10
KEEalarm SESAME	11
.....	11
<i>SESAME features</i>	11
KEEroll	12
Installation	12
<i>Control panel fixations</i>	12
Connections	13
Configuration / Starting up	15
<i>Connect the power supply</i>	15
<i>Adjusting limit switch</i>	15
<i>Options selection</i>	15
<i>Set courtesy light</i>	16
Programming	16
<i>Transmitter programming</i>	16
<i>Manoeuvre programming</i>	17
Verification	18
<i>Verify that the control panel is working properly</i>	18
<i>Communication's quality</i>	18
Maintenance	19
<i>Program maintenance manoeuvres</i>	19
<i>Reset manoeuvres counter</i>	19
Reset transmitters	19
<i>Reset safety elements</i>	20
<i>Fuse replacement</i>	20
Troubleshooting	21
Technical Data	21
RadioSens3 System	22
Installation	22
Impact detection adjustment	23
Programming	23
Maintenance	23

<i>Batteries replacement</i>	23
Troubleshooting	24
Technical Data	24
.....	25
.....	25
.....	25
.....	28
.....	29
.....	29
.....	29
.....	30
KEEpad & KEEpush	31
Installation	31
Programming	32
<i>KEEpad</i>	32
<i>KEEpush</i>	32
Verification	33
<i>KEEpad</i>	33
<i>KEEpush</i>	33
Maintenance	34
<i>Batteries replacement</i>	34
<i>KEEpad</i>	34
Troubleshooting	36
Technical Data	37
KEEalarm	38
Programming	38
Installation	39
Verification	39
Maintenance	39
<i>Deactivate the alarm</i>	39
<i>Rearm the alarm</i>	39
SESAME	40
Connections	40
Configuration	40
<i>Set up WiFi connection</i>	40
<i>Configure SESAME in "Honoa"</i>	41
Verification	44
Maintenance	44
<i>Resetting the device</i>	44
<i>LED behaviour</i>	45
Notes	46
Regulatory Data	48
UKCA Declaration of conformity	48
EU Declaration of conformity	48

Important safety instructions

Safety instructions for installation



Disconnect the power supply whenever you proceed to the installation, maintenance or repair of the equipment.

- Before installing the panel, remove all unnecessary ropes or chains and disable any equipment such as locks that is not necessary for the automatic operation.
- Before installing the panel, check that the door is in good mechanical condition, correctly balanced and that it opens and closes correctly.
- Install the manual unlocking device at a height lower than 1.8m.
- Install any permanent control next to the door away from any moving part and at a minimum height of 1.5m.
- For permanently connected equipment, an easily accessible power disconnection device must be incorporated into the wiring. It is recommended that this be of the emergency switch type.
- If the control panel is supplied without emergency stop button, this will be incorporated in the installation, connecting it to the STOP terminal.
- For correct use of the security edge, this must never be activated when the door is fully closed. It is wise to install the ends of run before activating the edge.
- This equipment can only be handled by a specialist fitter, by maintenance staff or by a suitably trained operator.
- To connect the power supply and motor wiring, 2.5 mm² section terminals must be used.
- Use protective goggles when handling the equipment.
- Fuses must only be handled when the appliance is disconnected from the mains.
- The instructions for using this equipment must remain in the possession of the user.
- European door normative EN 12453 and EN 12445 specify the following minimum protection and door safety levels:
 - for single-family dwellings, prevent the door from making contact with any object or limit the force of contact (e.g. safety band), and in the case of automatic closing, it is necessary to complement this with a presence detector (e.g. photocell).
 - for communal and public installations, prevent the door from making contact with any object or limit the force of contact (e.g. safety band), and complement this with a presence detector (e.g. Photocell).



WARNING: IN ACCORDANCE WITH THE EN 13241-1 AND EN 12453-1 STANDARD CONCERNING PRESSURE MAINTAINED CONTROL DEVICES:

“The person operating the door must have a direct view of the doorway, must be near the door (5 meters maximum) during movement of the door and should not find itself in a dangerous position”. Any adjustment of the radio range out of these recommendations, undertakes the installer in terms of responsibility for injury or damage.

“Releasing of the pressure maintained control device should stop the door movement before it scrolls 5cm!”.

Safety instructions for the use

- Do not allow children to play with the door controls.
- Keep the remote controls out of the reach of children.
- Watch the door movement and keep people away until the door is fully open or closed.
- Precaution when operating the manual unlocking device, as the door may suddenly fall due to the bad condition of the springs or door unbalance. Details on how to use the manual unlocking device must be provided by the manufacturer or the device installer.
- Examine the installation frequently, especially the cables, springs and supports, to detect signs of wear, damage or unbalance. Do not use the door if repair work or adjustments are required, as this may cause damage.

Use of the equipment

Designed for automation of garage doors, in accordance with the general description. Not guaranteed for other uses. The manufacturer reserves the right to alter equipment specifications without prior notification. No liability can be accepted for errors and misprints.

Introduction

KEEroll

Designed for residential aluminium roller shutters, the KEEroll solution has direct communication with the user and the installer.

Its capacitive front with illuminated keys provides comfort and security. The door can be opened and closed by any person without the need for technical know-how. The installer requires no initial training in the product.

The control panel can incorporate the most advanced system for detecting obstacles via radio, without wires. Ready to work with RadioBand3 or RadioSens3 to comply with all safety regulations. It's clean, quick and straightforward.

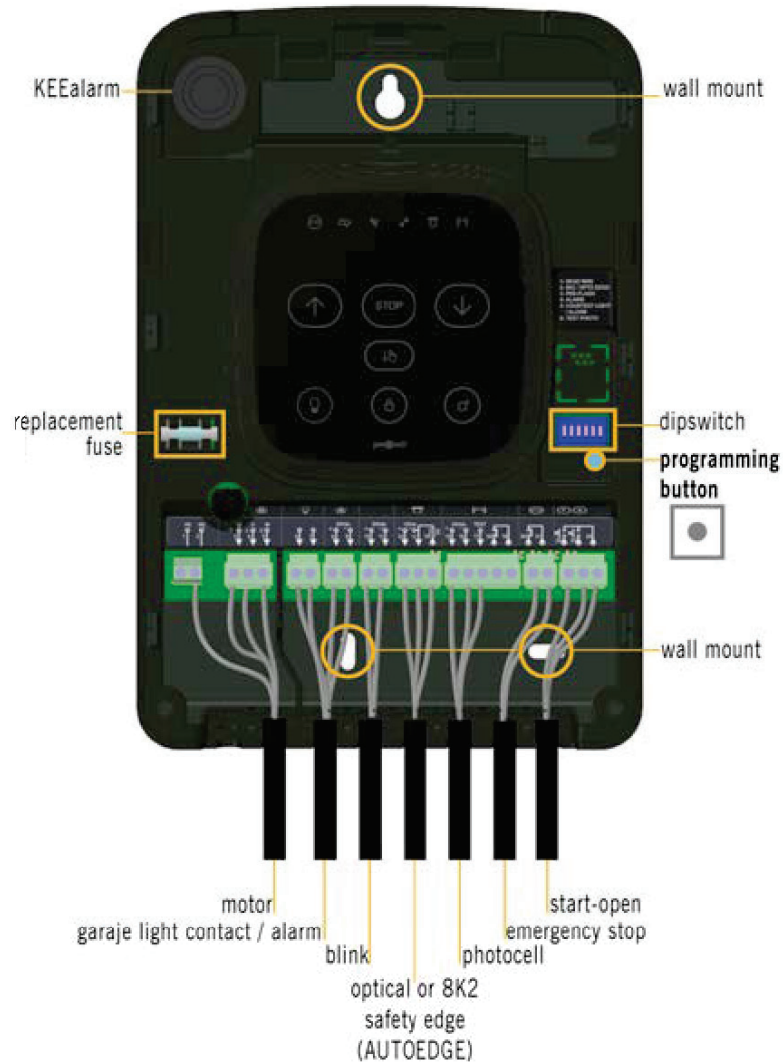

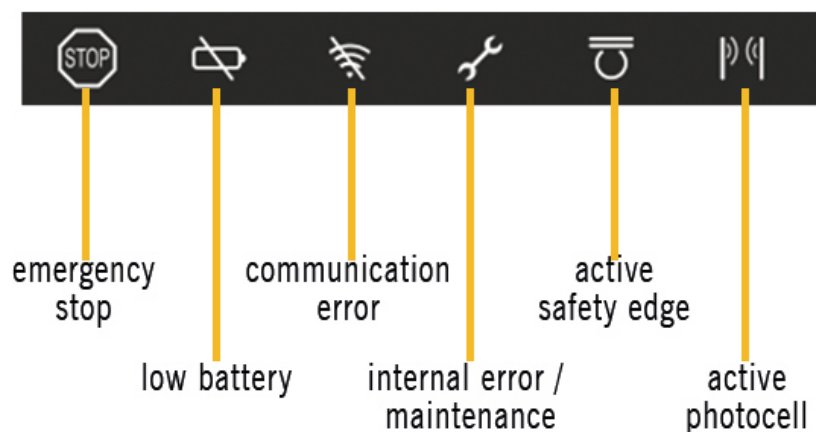

The system complies with standard EN ISO 13849-1: 2008, category 2, PLc.

Indicators

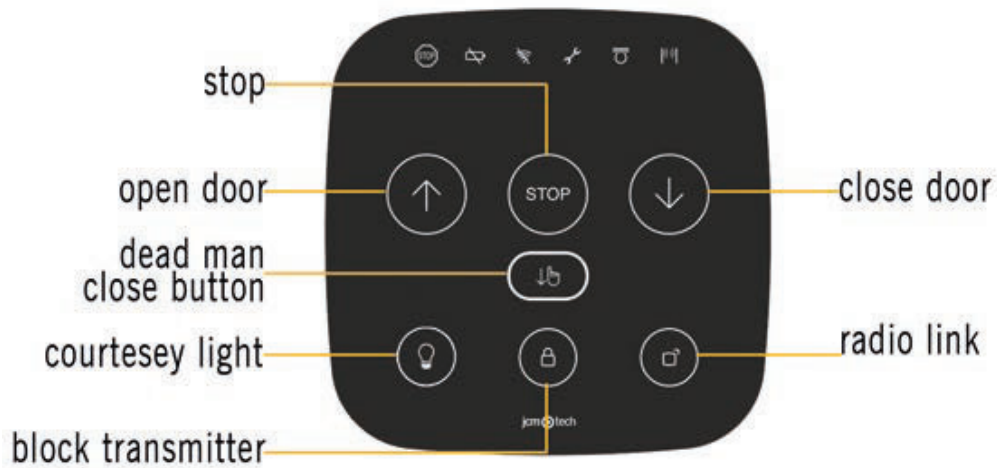

Actions



	<p>Press to open, stop and close the door.</p>
	<p>Press to close the door in dead man mode.</p>
	<p>Block transmitter function: KEERoll control panel incorporates a block button on the cover to prevent the door from being opened accidentally.</p> <p>Press  to block the door, key lights on. The control panel will not be able to move the door neither to receive any transmitter. Useful function to block the door during the night.</p>
	<p>Adjust courtesy light activation time: The user can set the desired time to leave the courtesy light at on simply by pressing a button on the cover.</p>
	<p>New transmitters: The user can program new transmitters simply by pressing a button on the cover (deleting transmitters is an action that is only allowed in installer mode).</p>
<div style="background-color: #f4a460; padding: 10px; border-radius: 10px;">  <p>ALARM device is necessary to activate this function</p> </div>	<p>Alarm function: With the ALARM accessory it is possible to detect unwanted openings of the door (robbery), enabling the control panel's sound alarm to be activated, or even connecting it to the alarm system already present in the home.</p> <p>With door totally closed, if someone tries to move it manually, the alarm will be activated.</p> <p>To stop the alarm, press any button of a programmed transmitter.</p>

RadioSens3 System

RadioSens3 is an impact detection system installed at the last slat of the roller shutter. It detects the obstacle and reopens without causing any damage.

The communication system between the RS3 T868 and the KEeroll is permanently monitored (two-way link via radio).

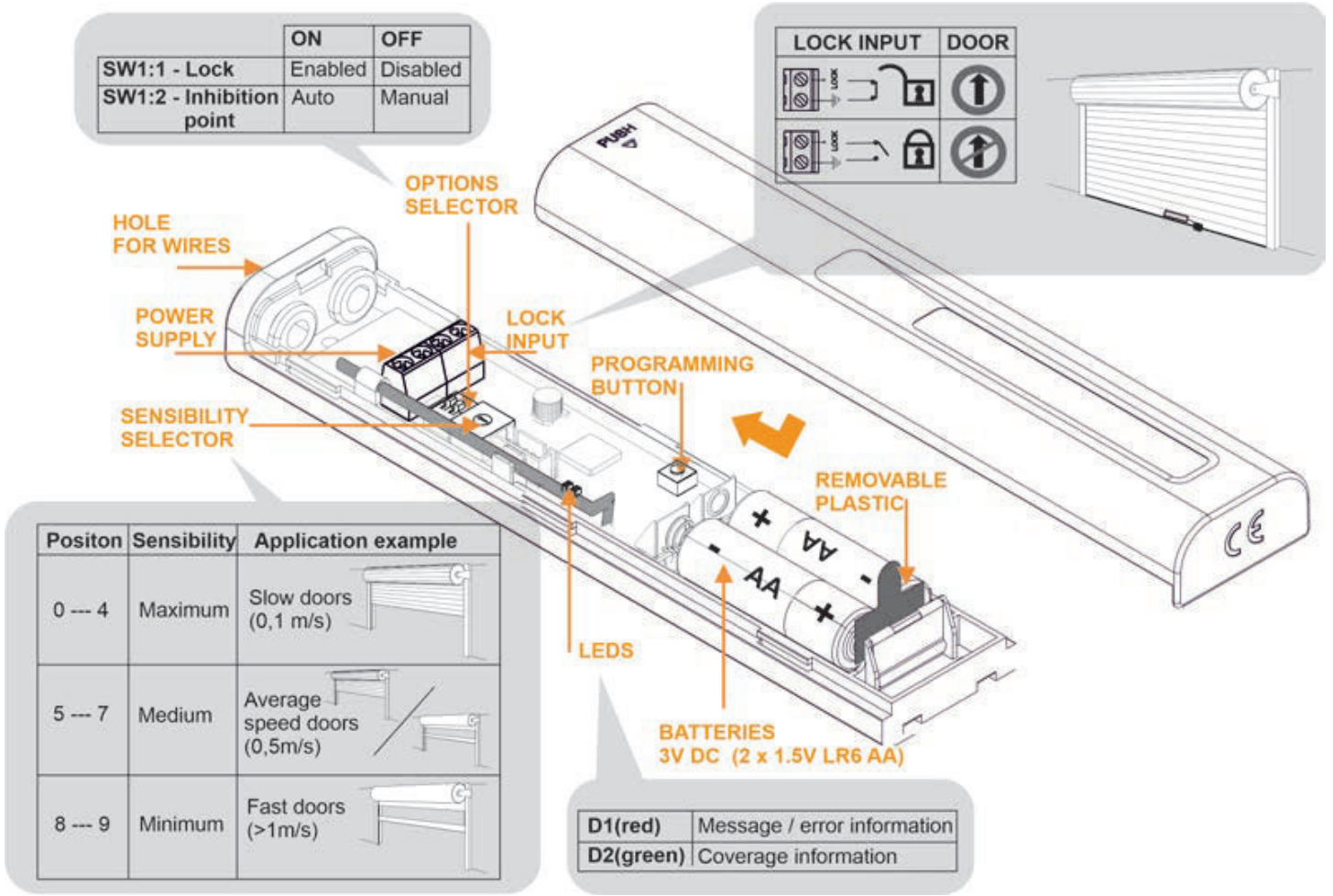

**Options and sensibility selectors must be set before programming.
Any later change will have no effect.**

Battery life

Table Battery life in days	Manoeuvres / day			
Manoeuvre time (s)	25	10	5	4
10	320	410	440	450
15	275	375	425	435
20	250	350	410	420
25	220	325	285	410
30	200	300	375	390

KEEpad & KEEpush

KEEpad

3-channel motion transmitter; 3 different functions (open / close door, switch on courtesy light, activate KEEALARM...). Each of these channels is activated with a different password.

Actions

- ① ... ⑨ DIGITS
- OK VALIDATION
- ⚙️ CONFIGURATION



Indicators

- 🔋 LOW BATTERY
- 🔧 INTERNAL ERROR / MAINTENANCE

KEEpush

3-channel motion transmitter; 3 different functions (open door, switch on courtesy light, ...)



KEEalarm

KEEalarm monitors your door and prevents a thief from quietly forcing your garage door.

KEEalarm is an accessory that monitors for intrusions. If a thief tries to open your door by force, an acoustic alarm will be triggered.



SESAME

SESAME is the device for controlling the residential door with the mobile phone.



- Supports up to 10 different users (licences).
- Licences renewable every 5 years.
- Compatible with any router via Wi-Fi.
- Detection and resolution of issues through web.
- Compatible with Android 5.0 and iOS with the free JCM Honoa app.

SESAME features

- Check the status of the door in real time.
- Open and close the door from any location.
- Receive notifications everytime the door is open or closed.
- Safety devices low battery warning

Installation

Control panel fixations



Remove the front cover of the control panel. Install the bottom part on the wall in a vertical position, at least 1,5 meters over the ground and in accordance with the assembly instructions below.

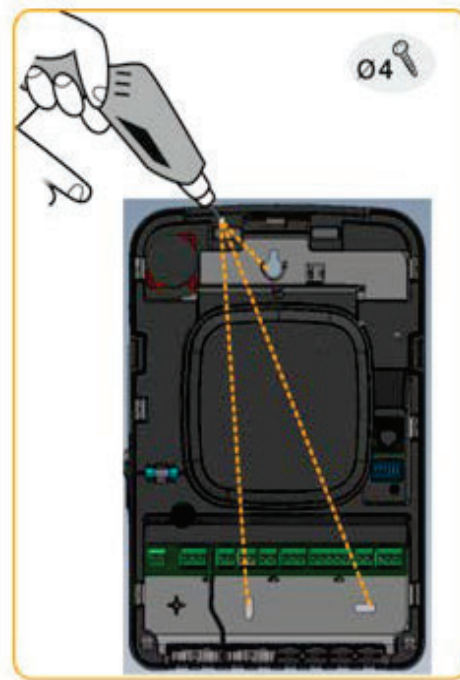

Connections



To prevent electric shocks, the equipment must be disconnected from the power supply and all the electrical connections.

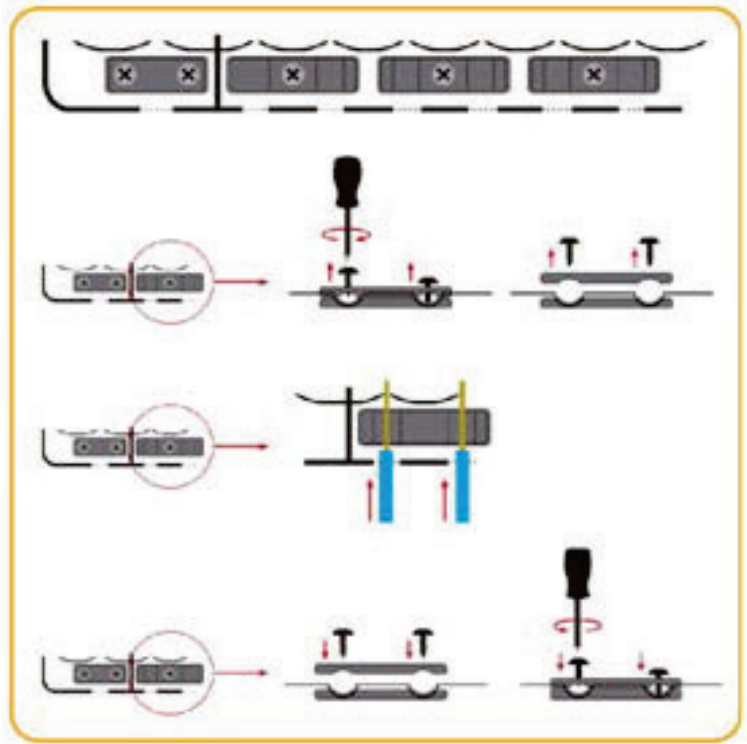

230VAC MONOPHASE MOTOR

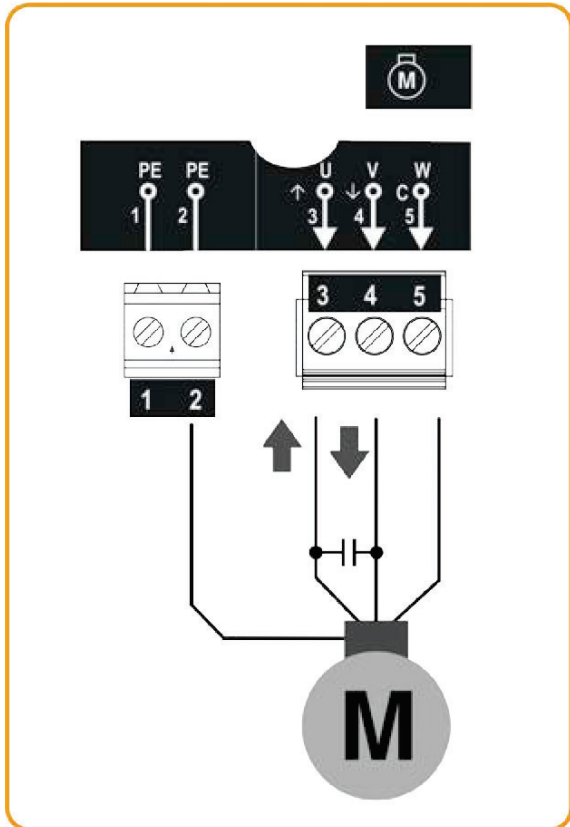

OUTPUTS

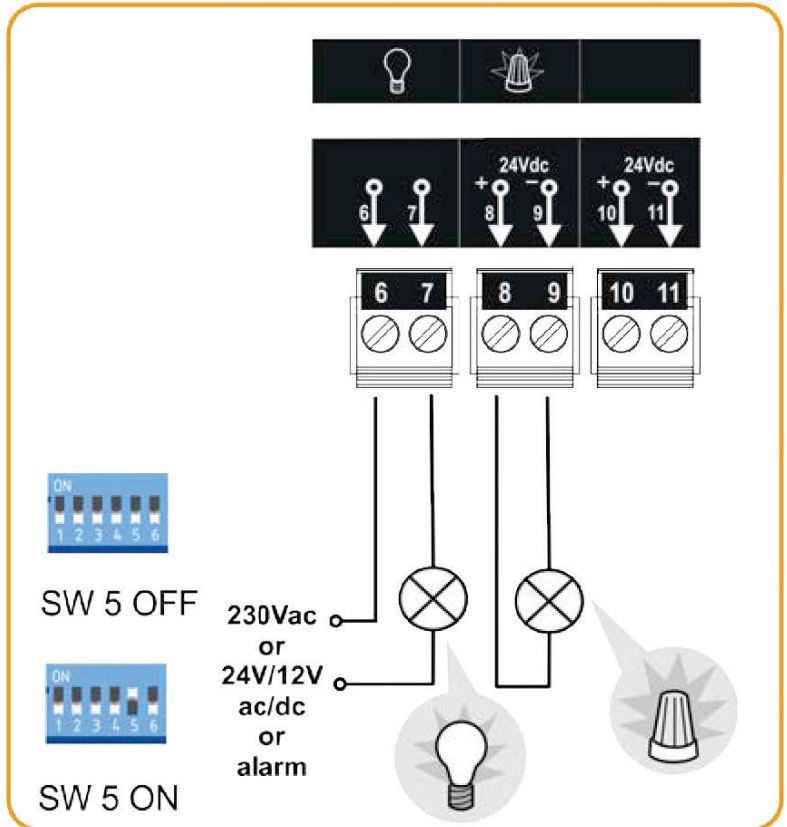

OPTO SAFETY EDGE / 8k2 SAFETY EDGE INPUT (AUTOEDGE)

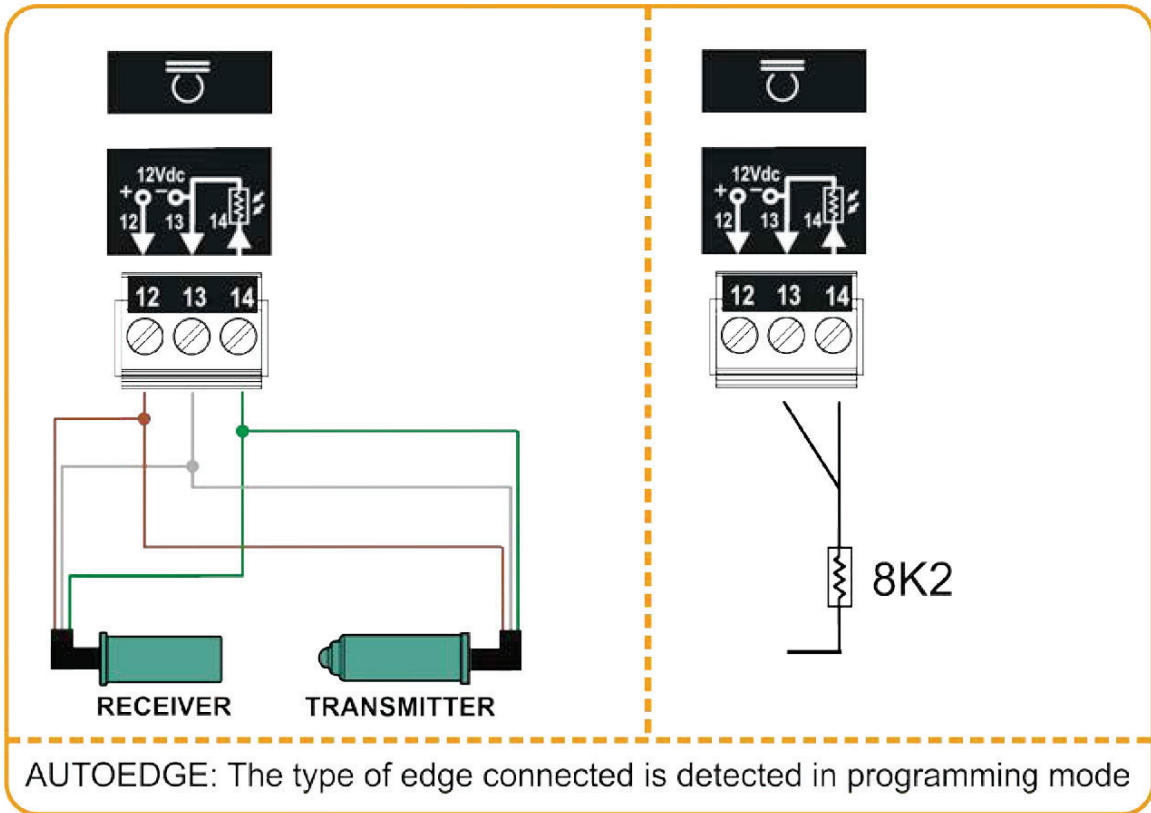

AUTOEDGE: The type of edge connected is detected in programming mode

PHOTOCELL INPUT

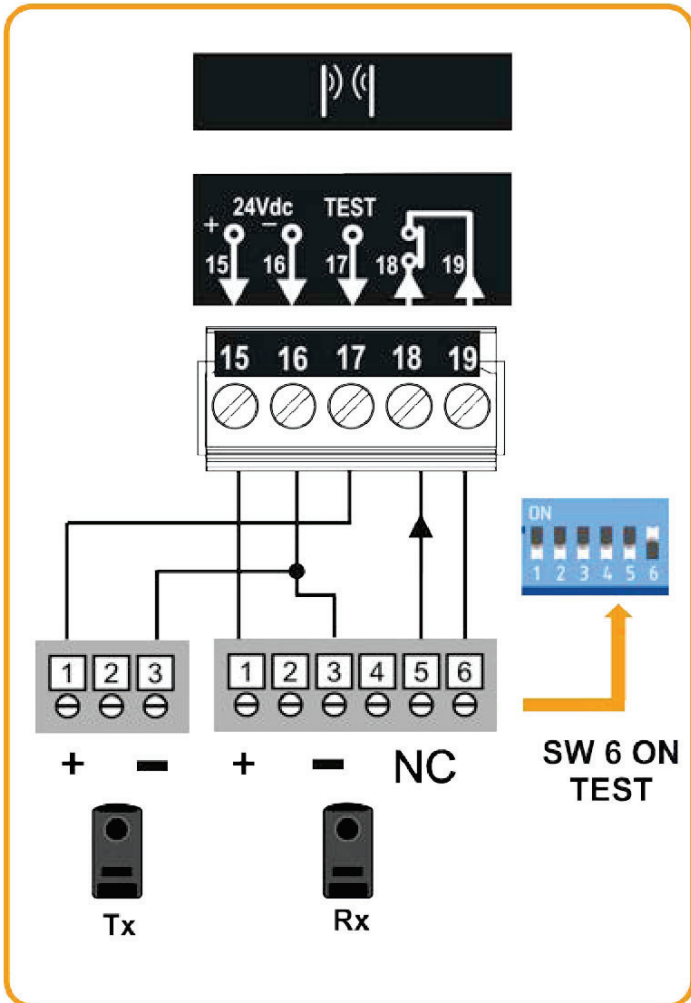

PUSHBUTTONS INPUTS

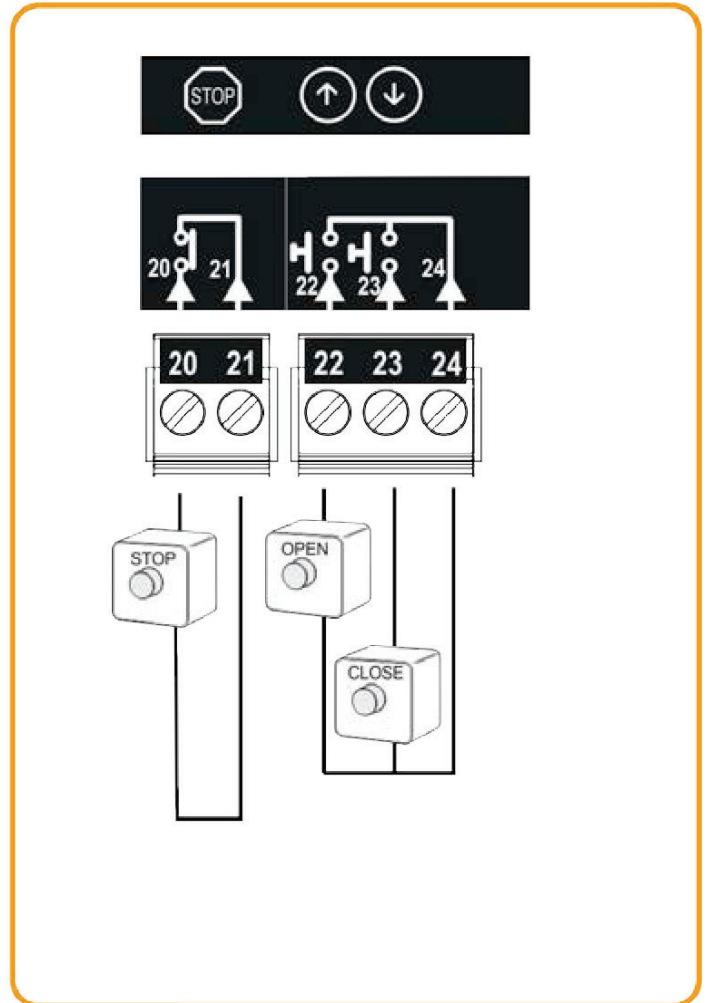



Configuration / Starting up

Connect the power supply

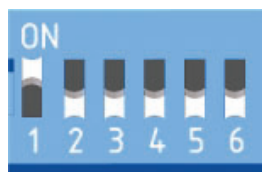
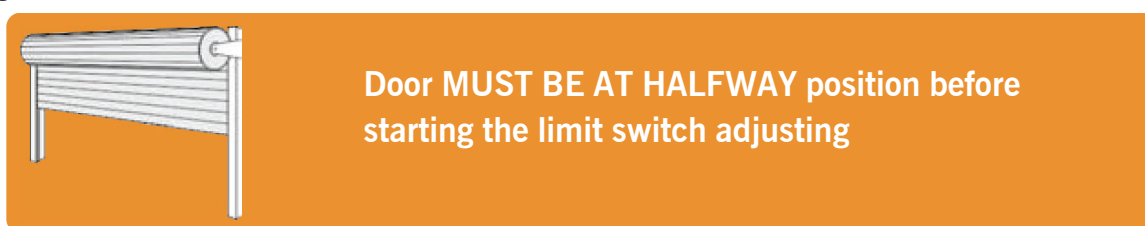

Adjusting limit switch



Dipswitch 1 in ON. Door will move in dead man mode. Keep pressed  or  to move up or down the door.

Press , to change the phase of the motor in case the door is not moving in the proper sense.

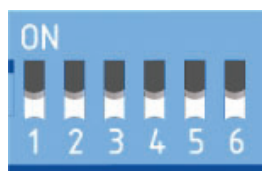

Dipswitch 1 in OFF to exit dead man mode.

Options selection

Dipswitch function	OFF	ON
1- DEADMAN	Normal operation	Dead man operation
2- AUTOCLOSE	Do not close automatically	Close automatically
3- PRE-FLASH	Pre-flash disabled	3s pre-flash enabled
4- ALARM* (KEEalarm needed)	Alarm function disabled	Alarm function enabled
5- COURTESY LIGHT / ALARM	Courtesy light output	External alarm output
6- TEST PHOTO	Test photocell disabled	Test photocell enabled

* Optional alarm. JCM can provide you KEEalarm 

Set courtesy light

It is possible to define the activation time of the courtesy light.



To change the setting hold and release. Repeat this step until the desired setting is reached (see table).

You can only access settings with the door closed and the DIP 1 selector OFF.

Frontal light	Activation time
1 flash	Manoeuvre time + 1 minute
2 flashes	Manoeuvre time + 5 minute
3 flashes	Manoeuvre time + 10 minute
Fast flashes	Manoeuvre time + 1 second

Programming

Transmitter programming



Press the key (you hear a beep and the key lights on) until you reach the necessary channel settings (see "Transmitter programming" table for the different settings).

You can only access settings with the door closed and the DIP 1 selector OFF.



Front light	Indication
1 flash	Press the desired transmitter button to activate open / stop / close
2 flashes	Press the desired transmitter button to activate the courtesy light
3 flashes	Functionless
4 flashes	Press the desired transmitter button to activate the alarm (KEEalarm needed)
Fast continuous flashes	Multichannel: attribute respectively each button for each function

Press each transmitter button to be programmed, a beep will be heard each time a transmitter is programmed.



Press again to exit transmitter programming. The key light will switch off.











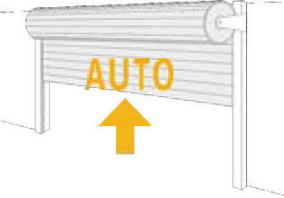
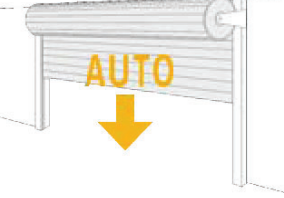

Manoeuvre programming

First program the safety elements (RadioSens3 or RadioBand3). Then program the manoeuvre.

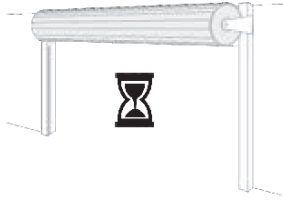
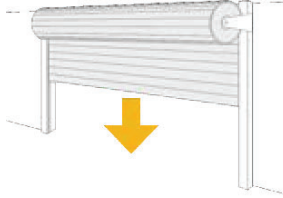

Door MUST BE TOTALLY CLOSED before starting the manoeuvre programming.

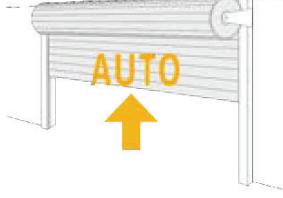
Enter Installer mode: Press  (KEEroll programming button), the maintenance indicator  lights on, a beep will be heard.

- 1-  Press , with the door totally closed, on cover and the control panel will initiate and auto- programming sequence.
- 2-  Door opens 2 seconds.
- 3-  Door closes automatically.
- 4-  Door stops.
- 5-  Door opens automatically.
- 6-  Door stops.
- 7-  Autoclose time.
- 8-  Press  on cover and door closes.
- 9-  Door stops.
- 10-  Door opens automatically.
*Only with RadioSens3
- 11-  Door closes automatically.
*Only with RadioSens3
- 12-  Maintenance indicator  lights off. End programming.

By default, RadioSens3 system adds an inhibition zone of maximum 4cm at the end of the closing movement. To modify the inhibit point: SW1:2 in the OFF position. (Image page 8)

It is possible to change the inhibition zone pushing  on when the door is closing (step 11). From this point, RadioSens3 will be inhibited.



STOP button aborts the programming sequence.

Verification

Verify that the control panel is working properly

Once the control panel is correctly wired and programmed, check that all the system (accessories included) is working properly.

Transmitter

Press the transmitter button and check that the door opens. Press again, and check that the door stops/closes.

Photocell

Check that the LED  is at OFF.



If the photocell is activated when the door's moving, the LED  will pass at ON, indicating the activation of the photocell.

RadioSens3, RadioBand3 system or safety edge



Check that the LED  is at OFF.

If the safety element is activated when the door's moving, the LED  will pass at ON, indicating the activation of the safety edge.

Communication's quality

To ensure that the radio communication is good enough, check that the LED  is at OFF. If  is permanently activated, please check RadioSens3/RadioBand3.

Maintenance

Enter Installer mode: Press  (KEEroll programming button), the maintenance indicator  lights on, a beep will be heard.

The following functions can be done inside this maintenance mode.



Program maintenance manoeuvres

Maintenance warning: By entering Installer mode you can set the number of manoeuvres for the maintenance warning. 

Keep pressing  to set up the maximum number of manoeuvres:





Frontal light	Indication
1 flash	2.000 manoeuvres (default)
2 flashes	3.000 manoeuvres or one year
3 flashes	5.000 manoeuvres or one year

Reset manoeuvres counter

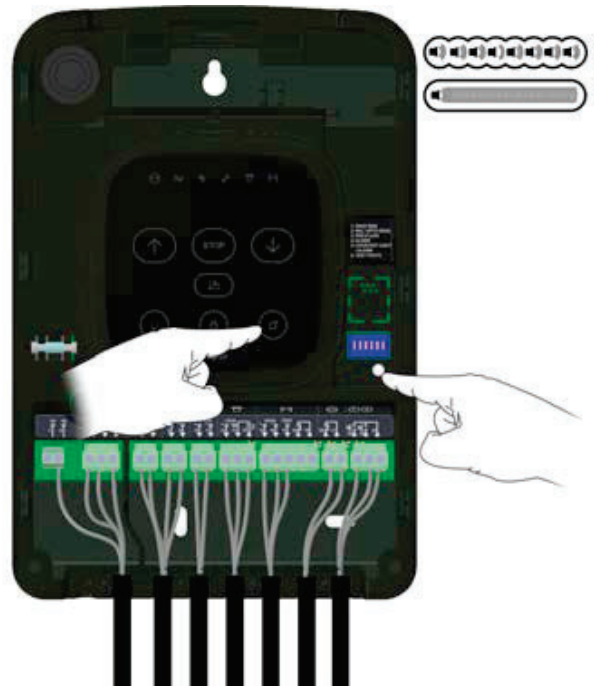
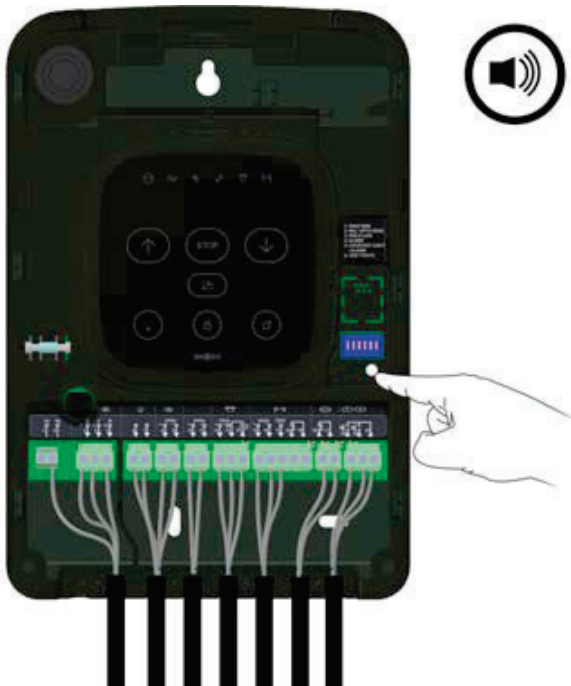
If the maximum number of movements is exceeded, the maintenance alarm  lights on, by pressing  there is rapid blinking and the number of movements is adjusted to 0



Reset transmitters

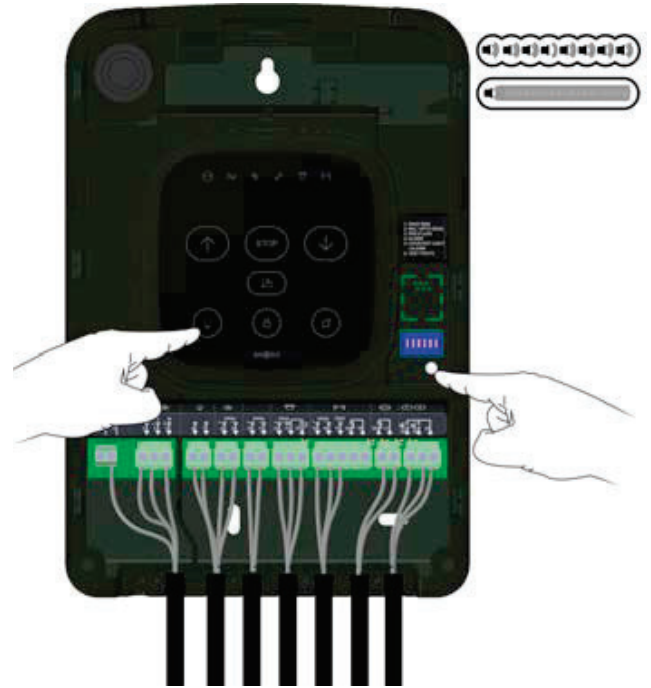
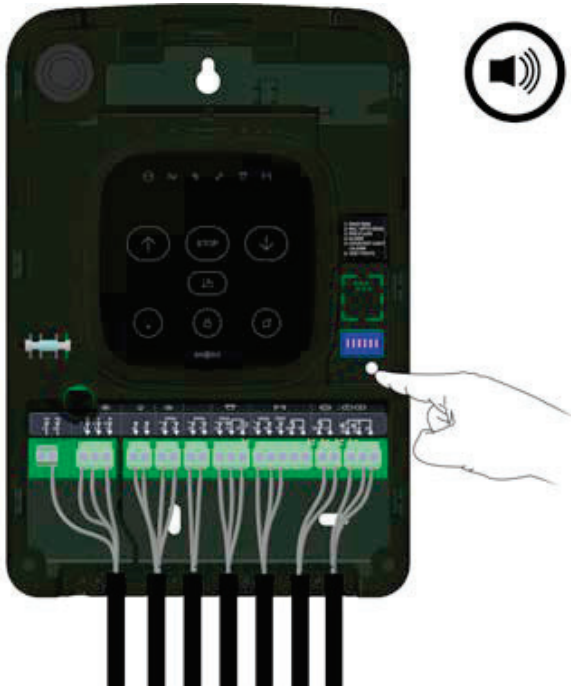

Hold  until  and  keys starts flashing, a beep will be heard. Without releasing , press  to erase transmitters, some beeps will be heard followed by a long beep.

Reset safety elements



Hold  until  and  keys starts flashing, a

beep will be heard.

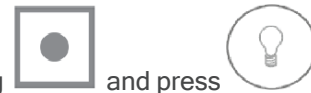

Without releasing  and press

, to erase safety







elements, some beeps will be heard followed by a long beep.

In case of erasing safety elements, the manoeuvre has to be reprogrammed again. See Programming chapter.

Fuse replacement

When you power supply the equipment, if the frontal panel does not light, remove the front cover and replace the fuse with another fuse with the same characteristics. You have a fuse available on the middle cover for the first time.

Troubleshooting

INDICATOR	ON	SOLUTION
	Emergency stop input activated	
	Low battery detection	Verify the batteries of the safety transmitter
	Radio communication error	Verify the radio signal. Check the batteries, reprogram again or change equipments location.
	ON: Installer mode Flashing: Maintenance warning	See Maintenance chapter
	ON: Closing photocell activation error Flashing: Indicates the reversed movement after a safety detection	
	ON: RS3 / Safety edge activation Flashing: Indicates the reversed movement after a safety detection	
	Flashing: KEEalarm is not sending the signal correctly	Check the batteries, verify that the installation or the programming is ok

In case of any safety error, the door can be moved keeping pressed the  or  or



or any other input controls.

Technical Data

Parameter	Value
Power supply range	230 V CA +/-10%
Stand-by / operating consumption	<60 mA / 200 mA
Maximum power supported	1,2 kW
Motor fuses	6 A
Operating temperature	-20 °C to 55 °C
Watertightness	IP42
Size (L/W/H)	180,0 x 277,4 x 57,5 mm

RadioSens3 System

Installation

Install the transmitter following the steps and recommendations below. Pass the cables through the holes indicated (only if you use the lock connection).

Install the transmitter in a horizontal position, at the middle of the last slat (it must have a tolerance of minimum 2mm of movement). Avoid placing metallic surfaces between the receiver and the transmitter.

It is recommended to use limit switches in the installation and to have them properly connected, or to assure that the door will stop always at the same point. The speed of the door must be uniform.

Options and sensibility selectors must be set before programming. Any later change will have no effect.

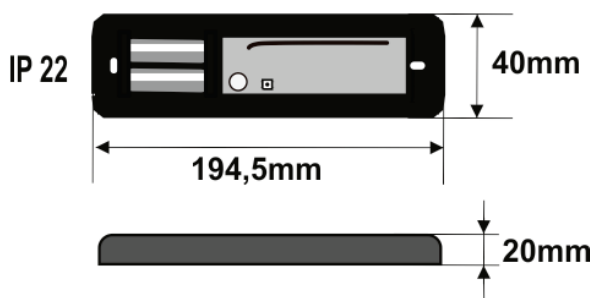

The last slat must have a tolerance of minimum 2mm of movement.

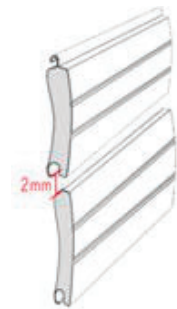

First, place the visor on the surface of the door to use it as template to make the holes in the door.

Then place the bottom part of the device. Screw the two pieces together.

Finally close the equipment with the top cover.

Control panel detects automatically the limit switches in the tubular motor. An adjustment of the limit switches before RadioSens3 installation is requested.

SWIPE TO OPEN COVER

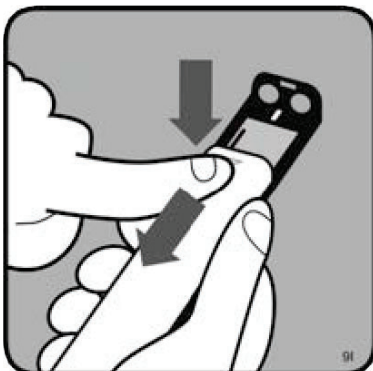

REMOVE COVER



DRILL DOOR

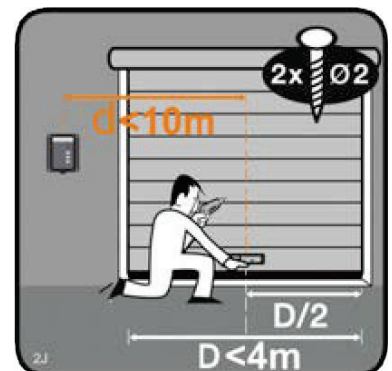

Maximum width of the door: 4 m. Recommended door speed: 0.1m/s or higher (and 17 rpm motors).

Impact detection adjustment



To adjust the impact detection of the RadioSens3 system, change the sensibility selector between 0 and 4.

Position	Sensibility	Application example
0---4	Maximum	Slow doors (0,1 m/s)
5---7	Medium	Average speed doors (0,5 m/s)
8---9	Minimum	Fast doors (>1 m/s)



If the position of the sensibility selector is changed, it is necessary to reprogram the RadioSens3 transmitter on control panel as safety elements programming (not the manoeuvre).

Programming

Enter Installer mode: Hold  (KEEroll programming button), the maintenance indicator  lights on, a beep will be heard.

Press the PROG button of RadioSens3 transmitter, a beep will be heard once it is programmed.

Press again  to exit Installer mode,  lights off and two beeps will be heard.



RadioSens3 and RadioBand3 cannot be programmed together. Only one of them can be operational.

Maintenance

Batteries replacement

If the led  is at ON, the RadioSens3 connected has no battery.

Proceed to replace the two batteries for new ones, taking care of the polarity marked on the connector. Check that the new batteries support the same range of temperature that the ones replaced. Do not mix new and old batteries. Battery duration: 2 years approximately.

Battery type: 2 x 1,5VDC LR6 AA

Troubleshooting

D1 red led	D2 green led	Message / issue	Solution
Flash at beginning of opening	OFF	Control panel asks RS3 correct signal transmitter to start the manoeuvre	---
Flash at beginning of closing	OFF	Indicates calibration failure of RS3 transmitter in open door status	Reprogram the manoeuvre until no calibration failure
ON	OFF	Indicates that the door is passing through the inhibition zones. It is only indicated in the first 25 manoeuvres	
OFF	ON	Indicates very good coverage	
OFF	Flash	Indicates very regular coverage	Align parallel the RS3 transmitter antenna and REC3 antenna
OFF	OFF	Indicates poor coverage or no coverage	Align parallel the RS3 transmitter antenna and REC3 antenna or change equipments location

Technical Data

Parameter	Value	
	Incorporated receiver	RS3 TGL868
Operating frequencies	Multifrequency system 868 MHz auto-adjustable (Channel 1: 868,700 869,200MHz, Channel 2: 868,000 -868,600MHz; Channel 3: 869,400 869,650MHz; Channel 4: 869,400 -869,650MHz)	
Memory	3 transmitters RBAND3 or 1 transmitter RSENS3	---
Standby / Operating consumption	---	0.3mA / 12mA
Radiated power	<1mW	
Range (in open field)	50m	
Battery life (approx)	---	See battery life table
Compatible equipments	RB3 T868, RB3 TGL868 and RB3 TGLA868 or RS3 T868, RS3 TGL868	Incorporated receiver
Watertighness	---	IP22
Reaction time (typical)	18 ms (max 48 ms)	
Maximum reaction time when interferences	466ms	
Operating temperature	-20°C to +55°	

KEEpad & KEEpush

Installation

Remove plastic from batteries

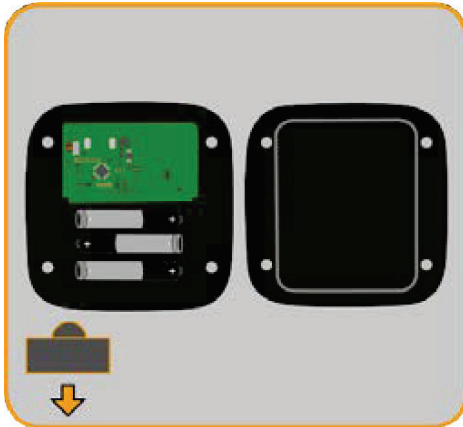

Save master code label in a safe place
(KEEpad)



Screw back cover

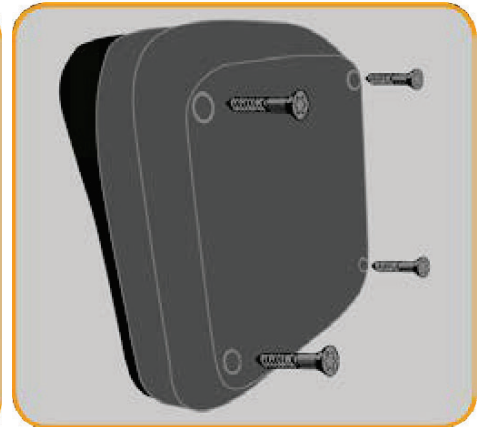

Fix support

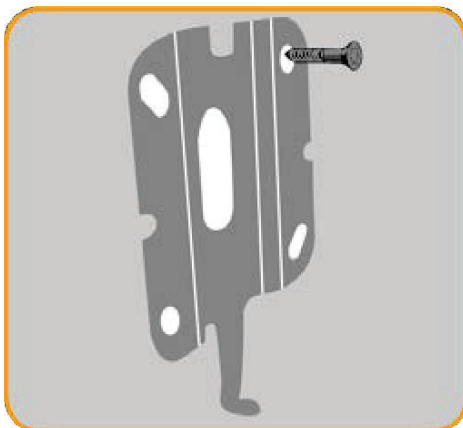

Slide on wall support

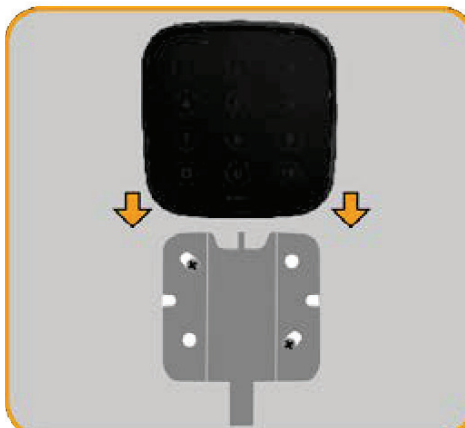

Fix device (use provided tool)



**Do not install near transmitting equipment of radiofrequency
(it could decrease the battery life time).**



Programming



Press the key (you hear a beep and the key lights on) until you reach the necessary channel settings (see "Transmitter programming" table for the different settings).

You can only access settings with the door closed and the DIP 1 selector OFF.

KEEpad

Wake up



Enter the channel password to be programmed + OK



 The defaults passwords are: 1111 for channel 1, 2222 for channel 2 and 3333 for channel 3.



KEEpush

Wake up

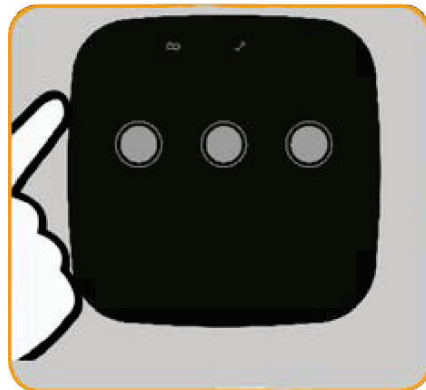

Press any button



Press  again to exit transmitter programming. The  key light will switch off.

Verification

KEEpad

Enter the password and check that the door opens. Enter the password again, and check that the door stops/closes.

Wake up



Enter the password + OK



The anti-spy feature allows you to press random numbers before entering the password (the KEEpad only uses the last digits).

KEEpush

Wake up



Press the button

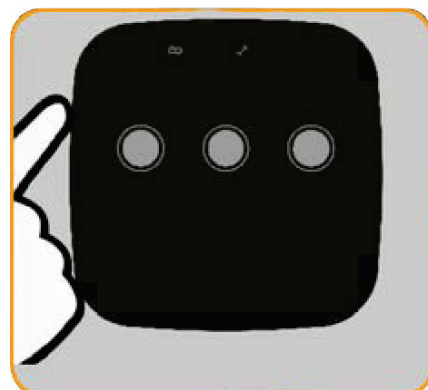

Maintenance

Batteries replacement

Unscrew device and slide on wall support

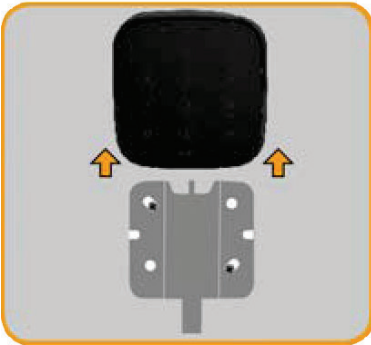

Unscrew back cover

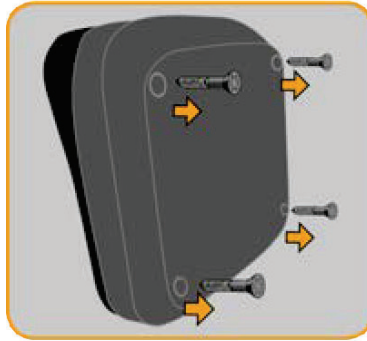

Replace batteries (3 x 1,5Vdc AAA type)



When batteries are near to the end of its useful life time, the  indicator flashes.

KEEpad

Configure password

Wake up



Enter configuration mode



Choose channel (1/2/3)



Enter current password (4-8 digits) + OK

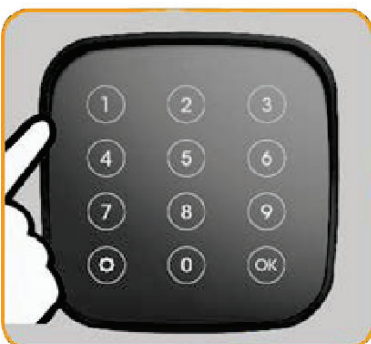

Enter new password (4-8 digits) + OK



If you do not remember the current password, you must reset the device (see "Reset", below).

Reset

Enter configuration mode



Select reset



Enter master code (see yellow label) +
OK



After a correct reset the default passwords are restored and, for safety, the keypad is reset from the receiver (it must be programmed again).



Troubleshooting

Issue	Solution
The device has the batteries inserted but it does not wake up.	Check if there is the factory plastic in the battery holder or if the batteries are empty.
The device wakes up but can not be programmed to the receiver.	Check the distributor code and installer code from both devices.
I do not find out the white label with the information of the device to know the distributor code.	Remove the bottom part of the device ad and open it, you will find out the white label on the electrical board next to the batteries
The device is installed properly but it is not detected by the receiver and they have the same distributor and installer codes	The nominal activation distance is 100 meters in open field, check it.
I would like to send 4 signals to the receiver with the device	The device only has 3 channels, as it's designed for a residential application: C1=Start-C2=Courtesy Light-C3=others.
I am trying to program more than 1 password for different users to activate the same door but it is not possible. The old one is erased.	Only 1 password can be programmed on each channel
The vibrator is not working.	Check if the battery icon is light ON, if yes the batteries are near to be empty
I am trying to change the master code but it is not possible.	The master code is fixed from factory.
I am trying to change the batteries but I do not know how to do it.	Remove the bottom part, change the batteries and install the bottom part again.
I would like to change the password and it is not possible.	You need the master code to do it.
The device was working and now it is not activating the receiver. The batteries are ok, the vibrator is ok. The other remotes are activating the receiver.	The device is broken, change it by a new one

Technical Data

Parameter	Value
Operating frequencies	868,35 MHz
Coding	High security changing code
Number of channels	3
Power supply	3 batteriesAAA 1,5V
Radiated power	<1mW
Operating consumption	12mA
Watertighness	IP65
Operating temperature	-20°C to +55°C
Autonomy	2 years (aprox)



Programming

The KEERoll dipswitch 4 in ON position.

Press the  key (you hear a beep and the key lights on) until you reach the necessary channel settings (see "Transmitter programming" table for the different settings).

You can only access settings with the door closed and the DIP 1 selector OFF.

In channel 4 configuration (4 flashes), slide the KEEalarm device in front of the magnetic part to activate the alarm. A beep will be heard to indicate that the device is programmed.

Press  again to exit transmitter programming. The  key light will switch off.

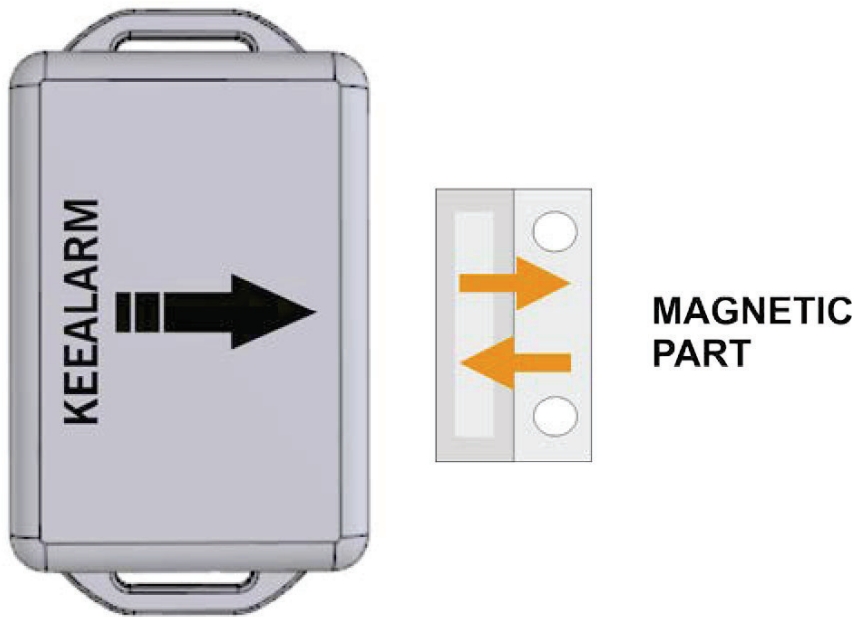

Installation

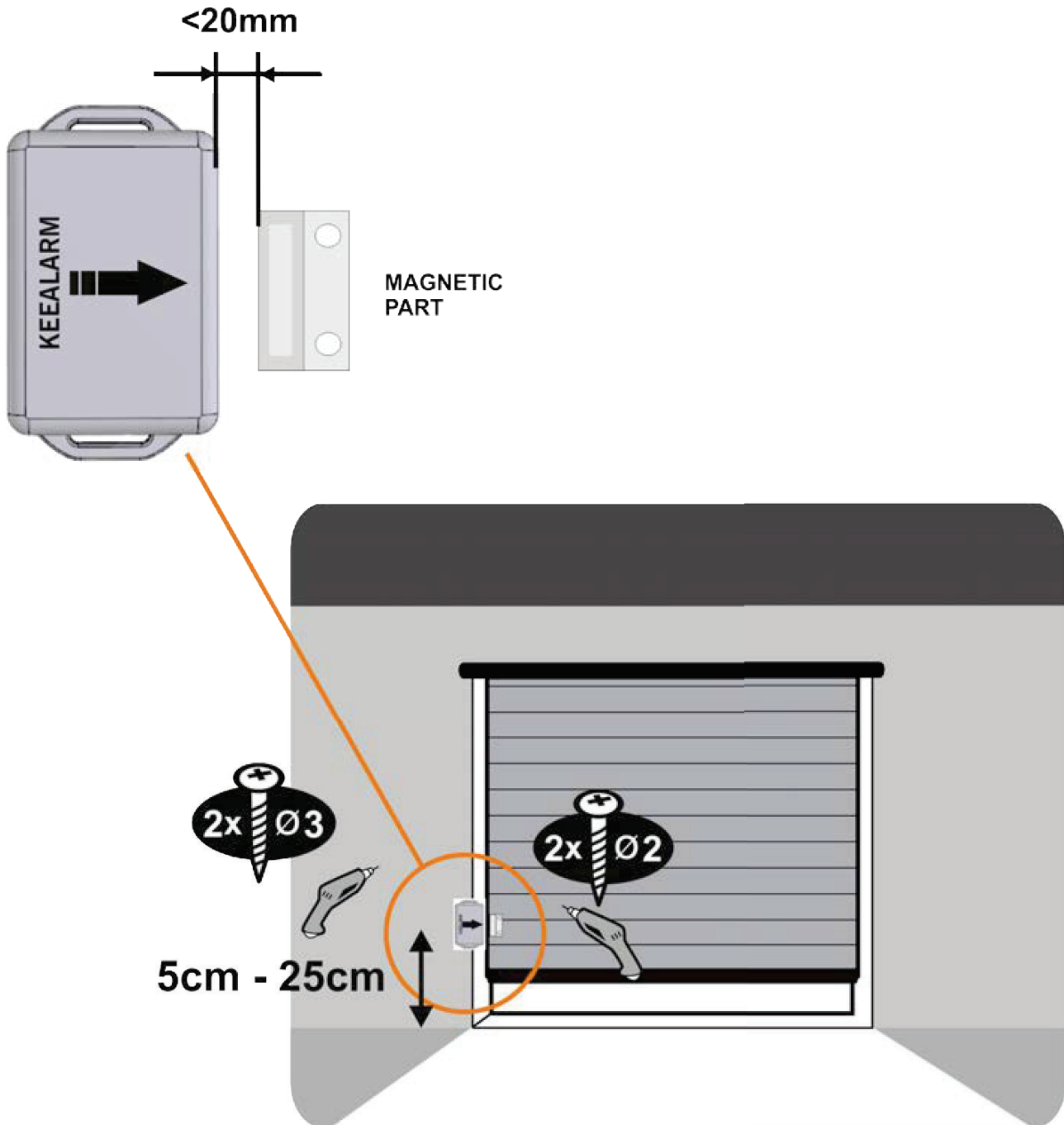

Verification

Make sure that the LEDs   are OFF

If it is activated when the door's moving, the LEDs   will remain at OFF, indicating the activation of the KEEalarm.

Maintenance

When the alarm is activated:

Deactivate the alarm

Press any button on a programmed transmitter.

Rearm the alarm

Open the door fully and then close it.

SESAME

Connections

Connect the SESAME device to your KEERoll control panel (use the RJ-45 connector). The LED status should be flashing green and the LED network should be flashing red, which shows that the device needs to be configured.

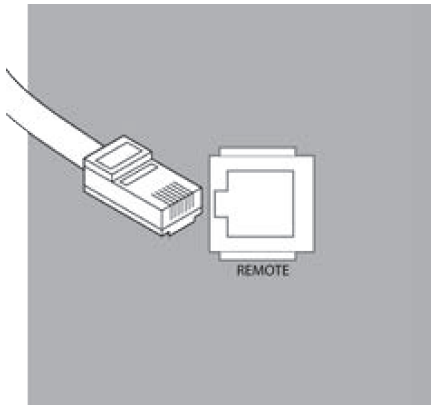

Make sure your control panel has this symbol on it's label, otherwise it won't work with Sesame.



Configuration

Once properly connected, the equipment's settings must be adjusted.

Set up WiFi connection

1. On your mobile: Settings -> WiFi & Networks -> WiFi (**search: SESAME_XXXXXXXXXX**, does not require password).
2. **Configure the SESAME_XXXXXXXXXX connection:** the settings website will automatically appear (if not, go to **192.168.4.1** on your browser).
 - 2.1. Look for your home WiFi (the signal must be **Good** or **Poor** for optimum operation) and input your home's WiFi password.
 - 2.2. Wait until the three LED are solid green, indicating that the WiFi connection has been successfully established. This operation may take a minute.

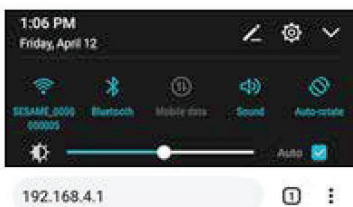

WiFi OK

Configure SESAME in "Honoa"

Once WiFi is set up, it is possible to add the device in JCM Technologies, S.A.'s mobile application "Honoa." If you do not have "Honoa" on your mobile, download the application.



You must login to enter the app. If you do not have an account, please register.

Within the application, press "NEWDEVICE." Scan the QR code from the SESAME device or enter "ACTIVATION KEY."

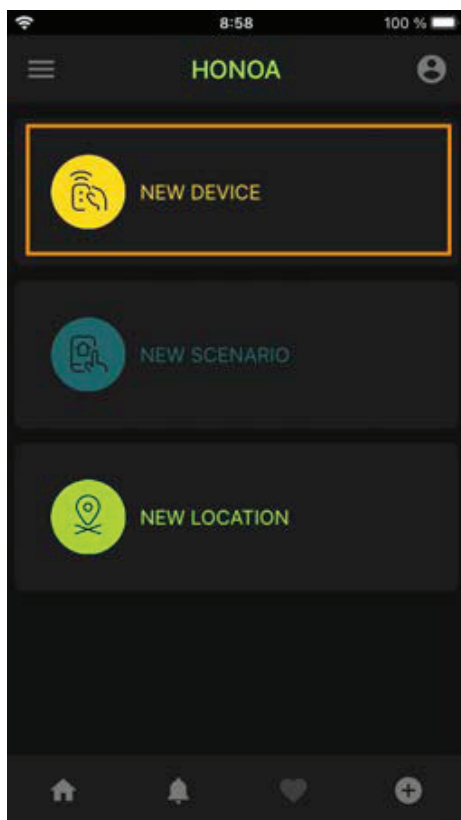

Complete the information in the fields "Device" (e.g., Sesame), "Place" (e.g., Garage house), and "City" (e.g., Barcelona), and press "SAVE." The device has now been added to the application.

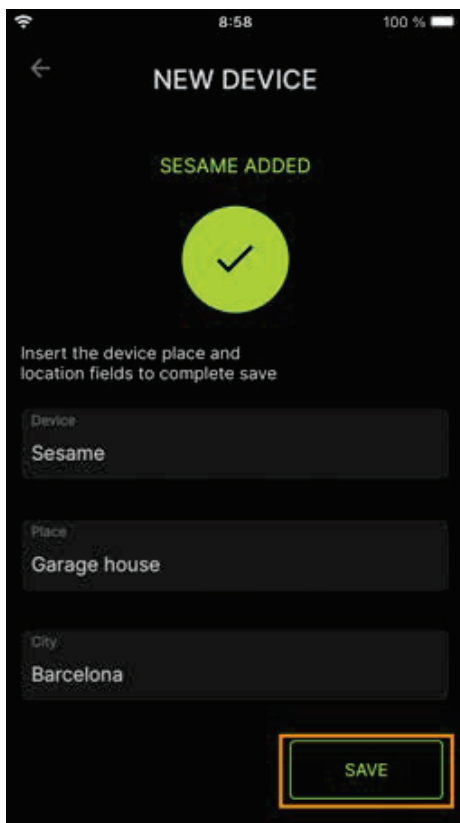

Licenses

Once the device has been added to the "Honoa" application, you must enter a license to be able to use it.

**2 licenses are inside the box.
If you need more licenses, please contact your distributor.**



Press on "GARAGE HOUSE" (Place) and, on the SESAME device, on "LICENSE."

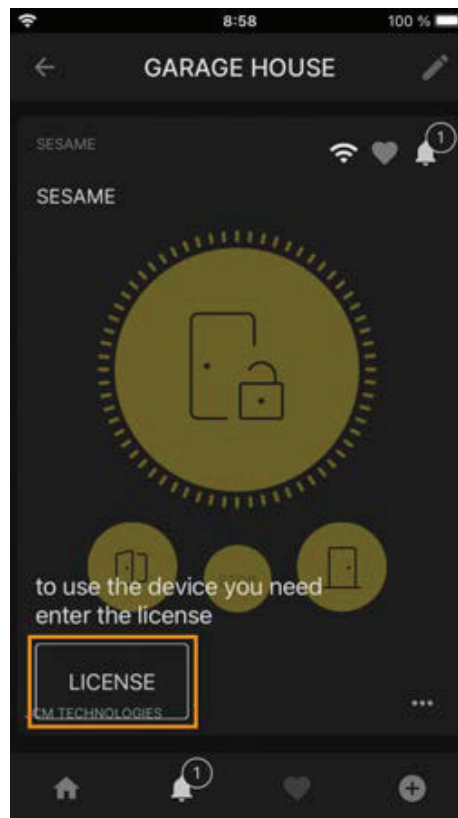
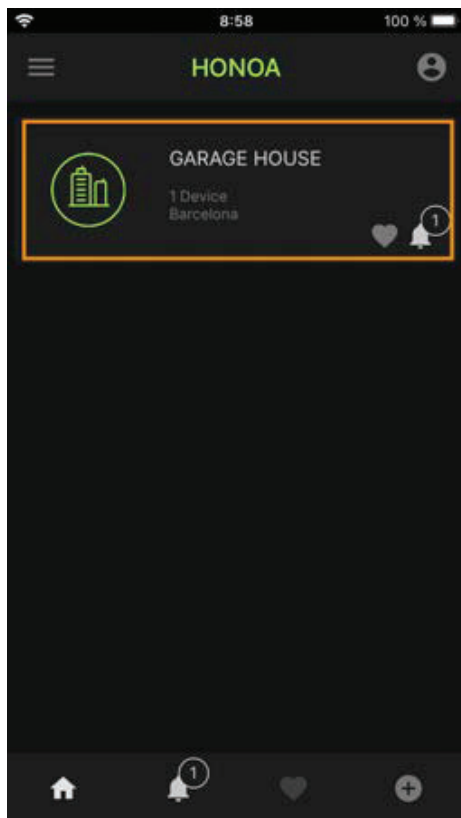

Scan the license's QR code or manually input the code. Press "SAVE."

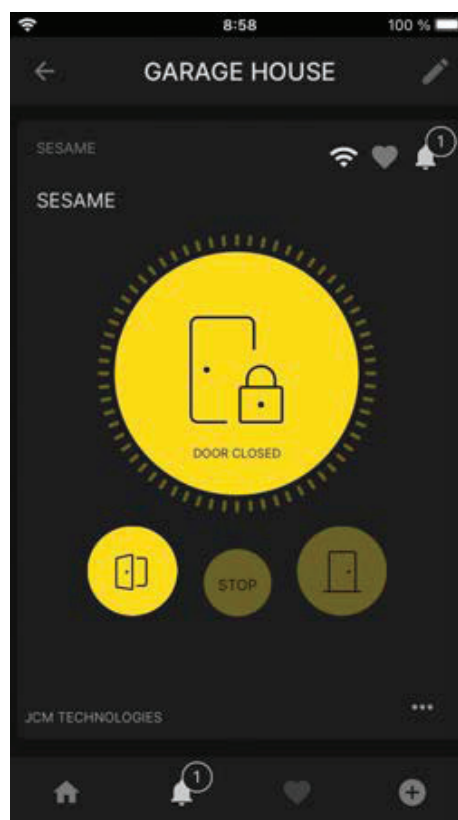

Verification

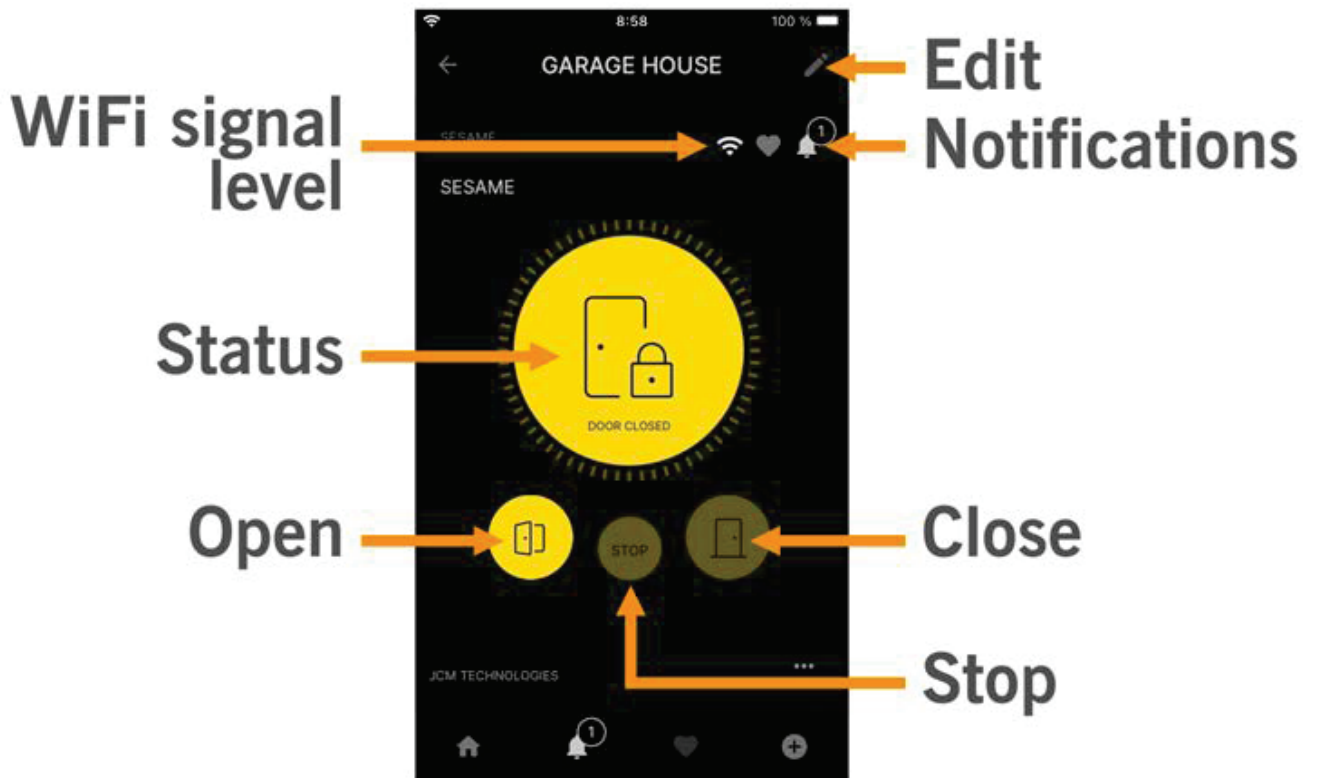

Maintenance

Resetting the device

Reset the device if changing the Wi-Fi network or your Wi-Fi password. To reset SESAME, press the WPS/ RESET button for 10 seconds, with the device connected. The LED "Status" will be set to green, and "Network" and "Internet" to flashing red. Stop pressing the button when "Internet" goes off and "Network" is fixed to red.

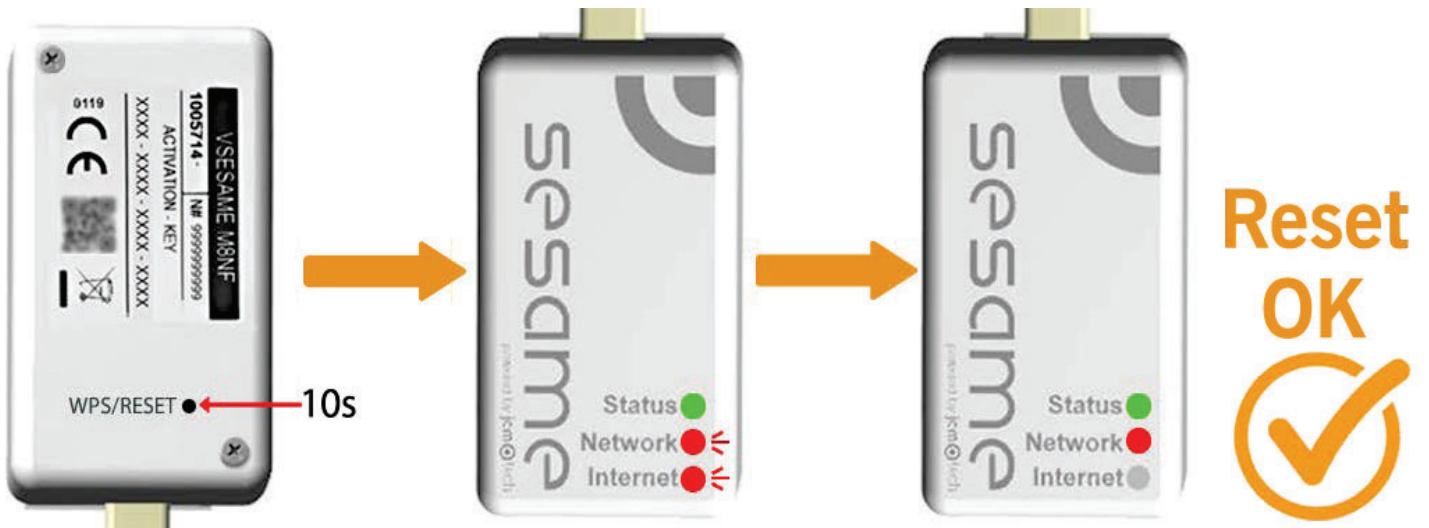

LED behaviour



OFF



FIXED



BLINKING

State	Status LED	Network LED	Internet LED	Action
Power off				-
Starting				WAIT
Wi-Fi Configuring				Use embedded web or WPS to configure connectivity
Wi-Fi Configuring timeout				REBOOT DEVICE
Connecting Wi-Fi				WAIT
Wi-Fi Error				WRONG WI-FI PASSWORD CHECK ROUTER (WI-FI)
Internet Connecting				WAIT
Internet Error				CHECK ROUTER (INTERNET)
Cloud Connecting				WAIT
Cloud Error				CALL TECHNICAL SUPPORT
Ready				-
Communicating				-
Reset				Keep reset button pressed
Update				WAIT

Regulatory Data

UKCA Declaration of conformity

JCM TECHNOLOGIES, S.A. hereby declares that the product **KEEroll** complies with the relevant fundamental requirements of the Radio Equipment Regulations 2017, as well as with the Supply of Machinery (Safety) Regulations 2008 whenever its usage is foreseen; and with the RoHS Regulations 2012.

EU Declaration of conformity

JCM TECHNOLOGIES, S.A. hereby declares that the product **KEEroll** complies with the relevant fundamental requirements of the RED Directive 2014/53/EU, as well as with the Machine Directive 2006/42/EC whenever its usage is foreseen; and with the 2011/65/EU RoHS Directive.

See website <https://www.jcm-tech.com/declarations/>

JCM TECHNOLOGIES, S.A.
C/COSTA D'EN PARATGE, 6B
08500 VIC (BARCELONA)
SPAIN



Before throwing away any device, the batteries must be removed and deposited in a collection point.