

# Installation & User Instructions

## SnapCOM 4G GSM Range

**PROFESSIONAL INSTALL ONLY**



Manual Version 1.0 (2022)

*The manufacturer cannot legally offer technical support to non-qualified gate or door installers. End users should employ the services of a professional install company to commission or support this product!*

**Tip:** Site Survey BEFORE you begin.  
See pages 3-4



**WARNING**

Do not power from the gate controller. Only use the provided UL power supply, otherwise damage may occur and warranty may be void.

# Index

Section	Pages
<b>PHASE 1 – SITE SURVEY</b>	<b>3 - 4</b>
Site Survey	4
<b>PHASE 2 – PRODUCT OVERVIEW</b>	<b>5 - 16</b>
Overview of Intercoms	6 - 7
More Detail....	8 - 11
PCB Module Overview	12 - 13
Sellable Code Table	14
Technical Specifications	15 - 16
<b>PHASE 3 - SETUP</b>	<b>17 - 22</b>
Preparation Before Configuration	18
Inserting the SIM & Power Connections	19
Status LED's	20
Check Reception	21
Set APN (for VOLTE / 4G service)	22
<b>PHASE 4 - INSTALLATION</b>	<b>23 - 30</b>
How to Achieve & Maintain IP55 Rating	24
Power & Solar Power	25
Battery Backup Option	26
Inserting the SIM & Power Connections	27
Relay Wiring Examples	28
Connecting Auxiliary Devices	29 - 30
<b>PHASE 5 – APP PROGRAMMING</b>	<b>31 – 33</b>
Set APN (for VOLTE / 4G service)	32
How to Use the AES PRO APP	33
<b>PHASE 6 – USING THE INTERCOM</b>	<b>34 - 37</b>
Calling a Resident & Using Keypad Codes & Prox IDs	35
Receiving A Call and Using Caller ID	36
Manager Controls of Gate / Door	37
<b>PHASE 7 – AFTERCARE</b>	<b>38 - 50</b>
Troubleshooting	39 – 41
Firmware Updates	42 - 46
App Updates / Intercom Maintenance /	47
Environmental Information	
Documentation Feedback	48
Warranty	49 - 50

# PHASE 1

## Site Survey

# Important things you Need to Know..



Please read this entire manual before installing this product.



To be installed by certified and qualified personnel / gate automation dealer only.  
**Not for DIY install!**



Ensure there is a good 4G signal on site. 4G units will fall back to 3G service in some countries.



Set up, on a bench in the workshop **BEFORE** going to the site. Program the unit in the comfort of your workbench and call technical support should you have questions.



This product requires a regular voice, SMS and data SIM card with an MMS plan. **Do not use a data-only SIM, as this will not work in the unit.**

To make voice calls on a 4G system and get optimum service, your SIM and provider will need to offer VOLTE support (Voice over LTE) otherwise the unit will be forced to fall back to 3G or 2G service to make calls.



Manufacturer warranty does NOT cover lighting/storm damage. In lightning prone areas, you **MUST** fit external surge protection and the lightning rod to maintain the warranty on this product.

# PHASE 2

## Product Overview

## Overview of Intercoms (Imperial Design)

Antenna Separate



## Overview of Intercoms (Architectural Design)

Antenna Separate

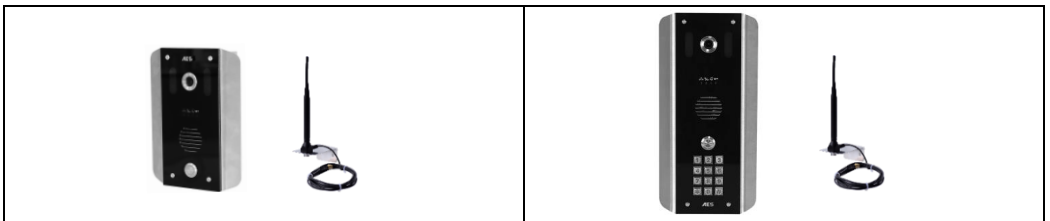

## Overview of Intercoms (Pedestal Design)

Antenna Integrated



## Overview of Intercoms (Flush Design)

## Antenna Separate



# More Detail....

Note: the numbers in the brackets (#) relate to the sellable code table on page 14

## SnapCOM Keypad Version Overview

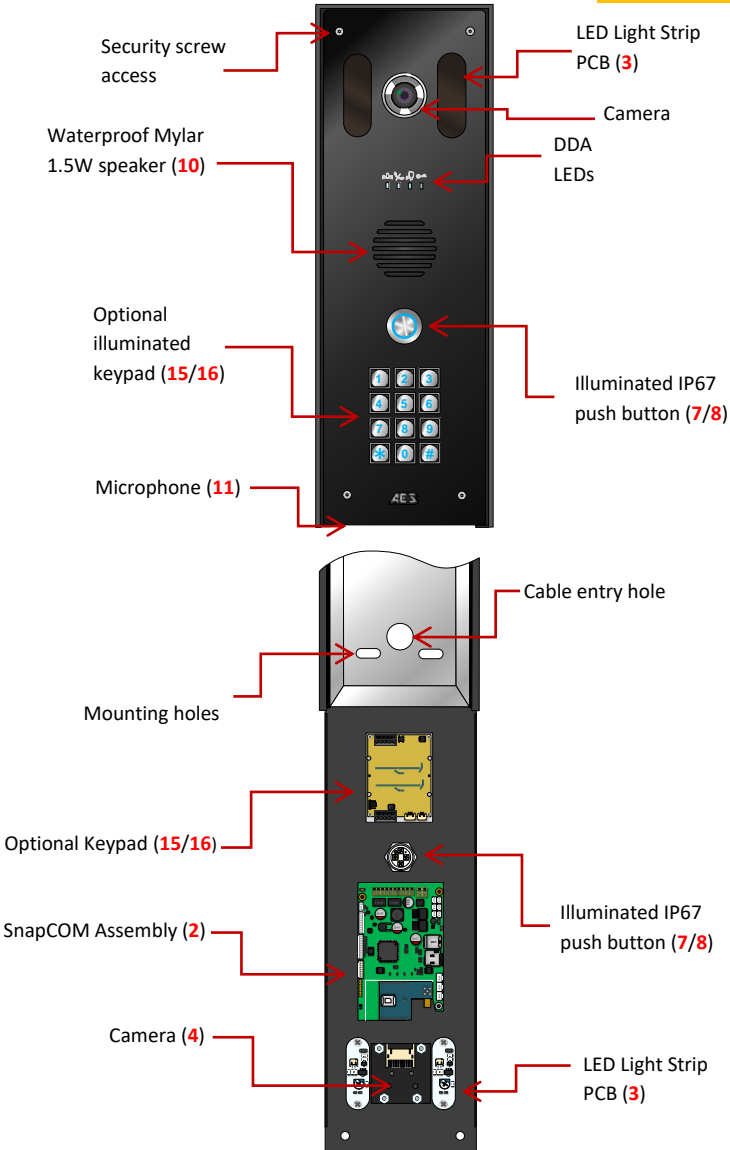



# SnapCOM Non-Keypad Version Overview

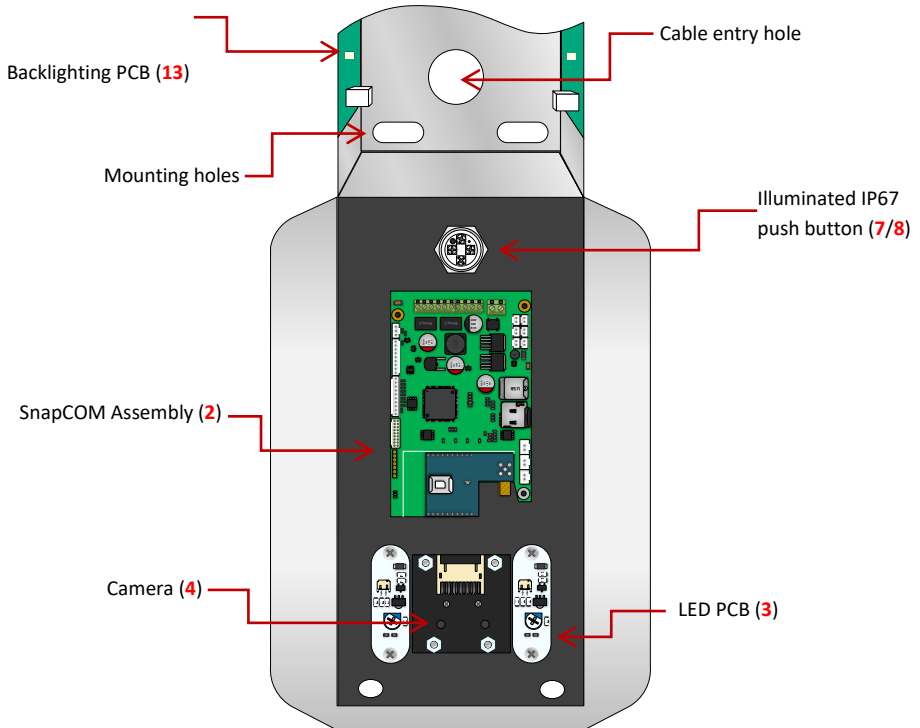

# SnapCOM Pedestal Overview

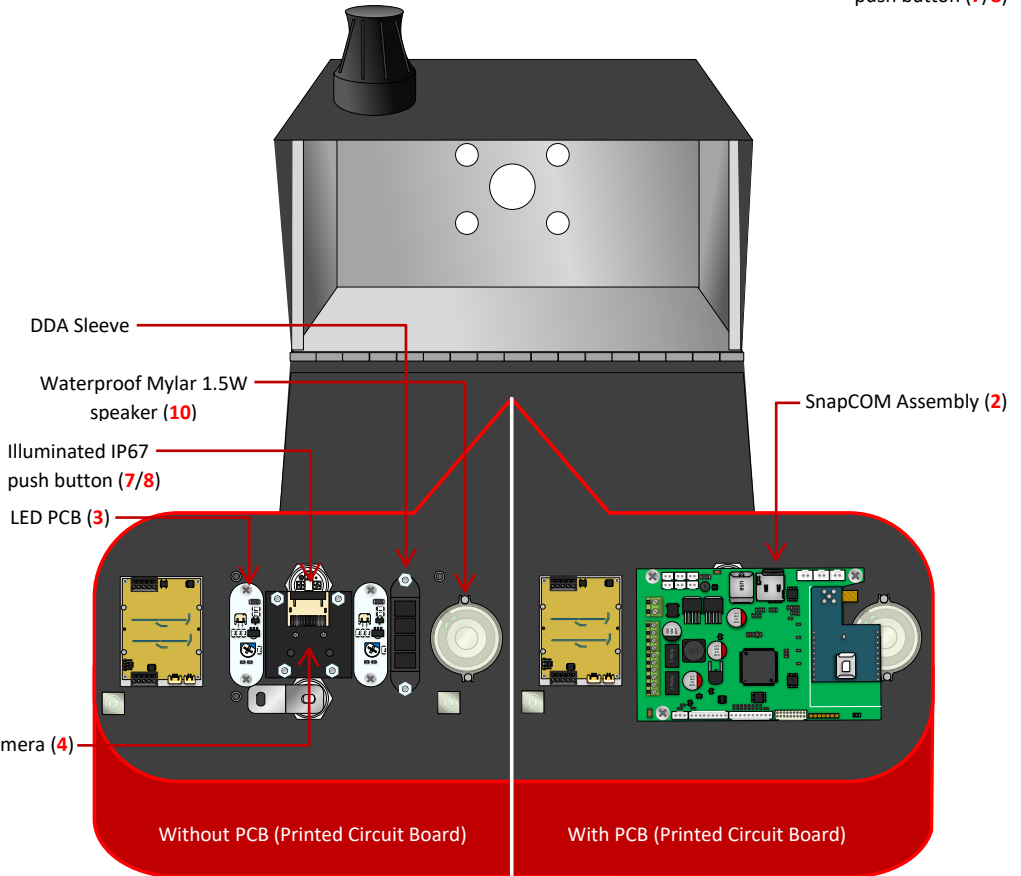
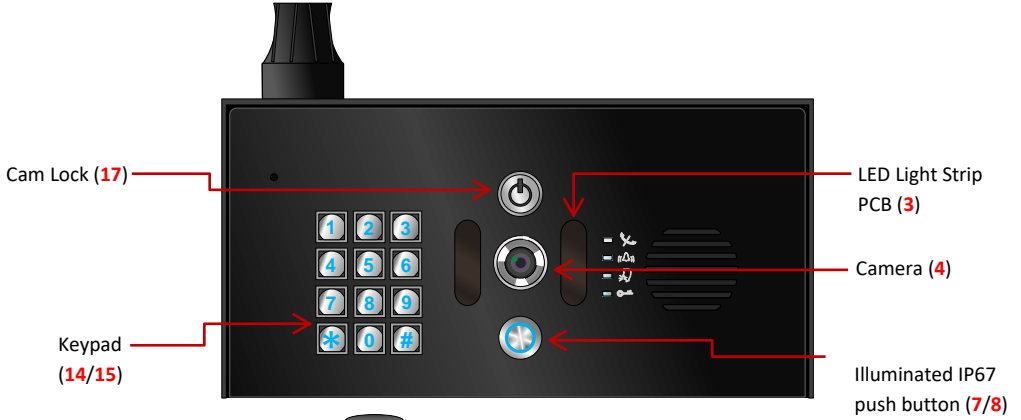

# Main GSM Module (2) in Detail...

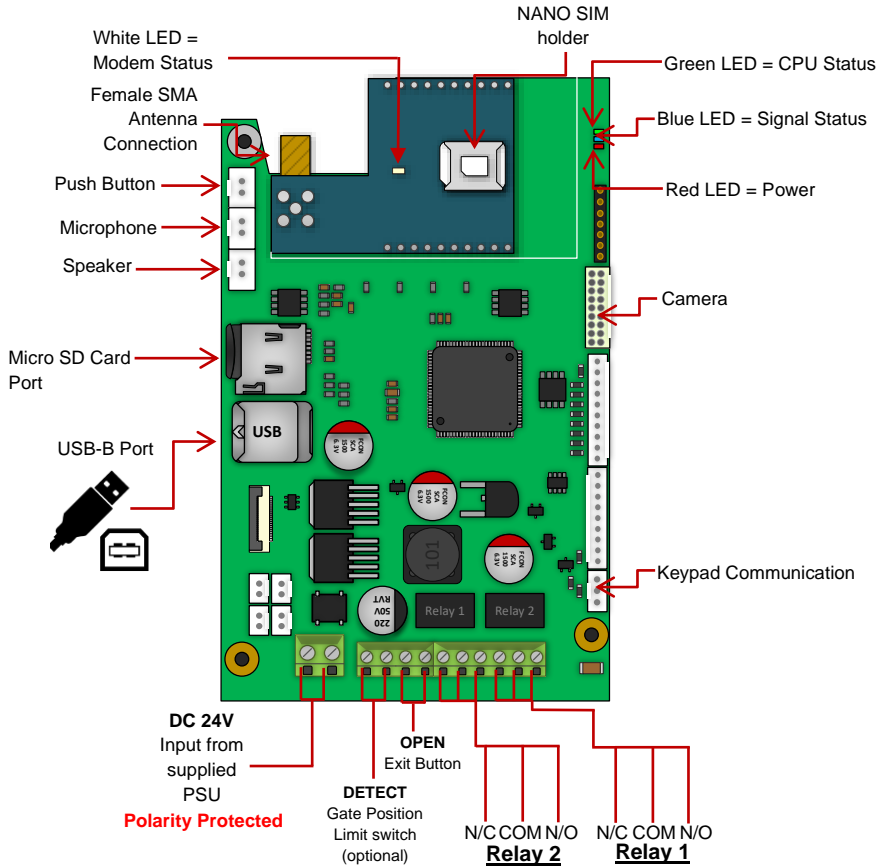

# Keypad Module (15/16) in Detail

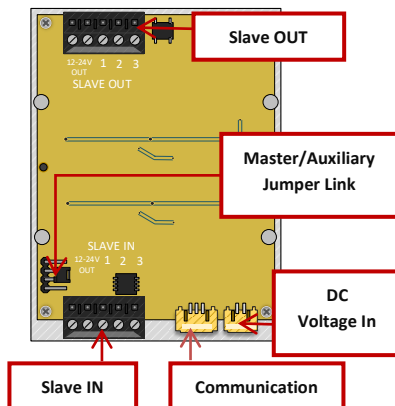

# Overview of Surge PCB (1)

\*optional extra

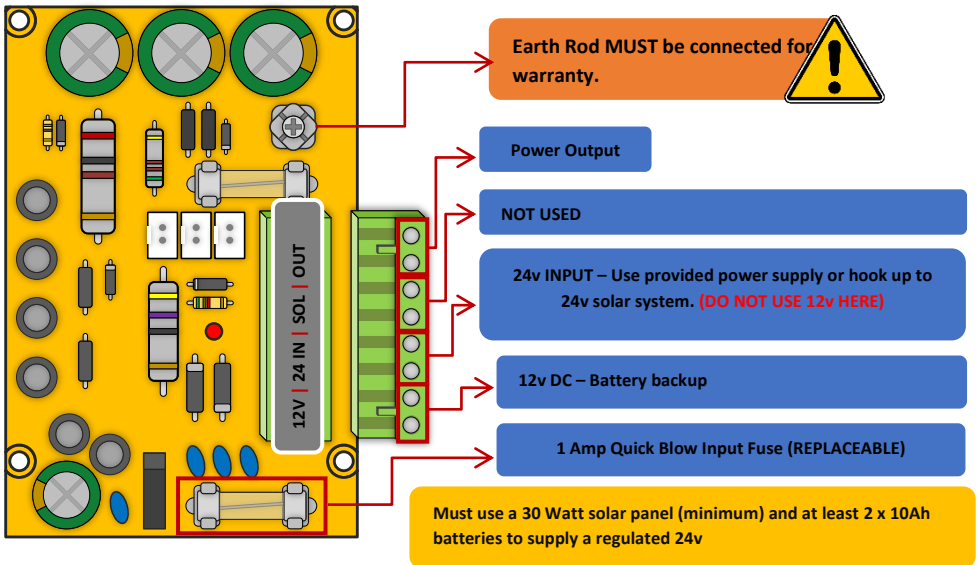

## Component Sellable Codes

	Component	Sellable Code
1	Surge PCB	SURGE3
2	SnapCOM PCB	SNAPCOM-PCB-EU
3	SnapCOM LED Strips	SNP-LED
4	SnapCOM Camera	SNAPCOM-CAM-PCB
5	SnapCOM camera cable (European)	SNAPCOM-CAM-LEAD-100
6	SnapCOM camera cable (Pedestal)	SNAPCOM-CAM-LEAD-150
7	Blue push button	BPB-24V
8	White push button	WPB-24V
9	No touch sensor	NT-BUTTON
10	Speaker	SPK-ASSM
11	GSM Microphone	MPA
12	Prox PCB and coil	PROX-PCB-PRIME6
13	Backlighting PCBs (blue)	LEDB-PCBA-ABK-V2
14	Backlighting PCBs (white)	LEDW-PCBA-ABK-V2
15	Blue prime keypad	PRIME-KP-B-KIT
16	White prime keypad	PRIME-KP-W-KIT
17	Cam Security Lock	IBK-LOCK

# Technical Specifications

GENERAL	
Front Panel	<p><b>Portrait Orientation</b> AB/ABK = 3mm Acrylic on Architectural Design Marine Grade Stainless Steel BS316 Front Plate</p> <p>FBK = 3mm Acrylic on Flush Design Marine Grade Stainless Steel BS316 Front Plate</p> <p>IBK = 3mm Acrylic on Imperial Design Marine Grade Stainless Steel BS316 Front Plate</p> <p><b>Landscape Orientation</b> PBK = Pedestal Surface Mount. Powder Coated Marine Grade Stainless Steel BS316 Front Plates with 3mm Acrylic on Design Marine Grade Stainless Steel BS316 Modular Plates</p>
Hood Cover (IBK, PBK)	Powder coated Aluminium
Mounting Housing (Backbox)	Marine Grade Stainless Steel BS316
Mounting Type	<p>AB/ABK = Surface Mounted</p> <p>IBK = Surface Mounted</p> <p>FBK = Flush Mounted</p> <p>PBK = Surface Mounted</p>
Call Button	Stainless-steel button with illuminated LED Ring
Power Supply	24V DC (24v dc 2A adaptor included)
Power Consumption	<p><b>GSM PCB w/Keypad &amp; Prox</b></p> <p>Standby Current: 120mA</p> <p>Dial Out: 400mA</p> <p>Max Current: 2A</p>
Solar Power	<p>30Watt Solar Panel (minimum)</p> <p>2x 12V 10AH Batteries connected in series to provide 24V output. The power output must be regulated.</p>
Ingress Protection:	IP55
Approvals	FCC, CE
Dimensions	See catalogue
Operating Temperatures	-15 to +55°C / -13 to 131°F
KEYPAD MODULE	
Backlighting	Blue / White
Baud Rate	9600
Code Length	4 Digits (fixed)
Confirmation Key	N/A

<b>GSM</b>	
Modem Models	4G Europe - SIM7500E -L1C
Frequency Range	GSM900 880-915MHz, DCS 1800 1710-1785MHz WCDMA Band I 11920-1980MHz, WCDMA Band VIII 880-915MHz LTE B1, B3, B7 1920-9180MHz, 1710-1785MHz, 2500-2570MHz LTE B8, B20 880-915MHz, 832-862MHz
RF Output Power (EIRP)	32.55dBm (GSM 900), 29.73dBm (DCS 1800) 23.77dBm (WCDMA Band I), 23.78dBm (WCDMA Band VIII) 22.79dBm, 22.73dBm, 22.97dBm, 22.35dBm, 22.99dBm (LTE B1, B3, B7, B8, B20)
<b>PROX TAGS</b>	
Dimensions	40 x 25 x 4.5mm
Frequency	125 KHz
Type	Passive, fixed 10 digit.
Storage Temperatures	.-40°C to +85°C (-40°F to 185°F)
Operating Temperatures	.-40°C to +55°C (-40°F to 131°F)
Ingress Protection:	IP68
<b>TECHNICAL DETAILS</b>	
Dial Out Numbers	4
Automatic Trigger Events per Week	50
Modem Models	4G EU, 4G USA, 4G AUS/NZ
Relays	2
Relay Type	N/C and N/O
Relay Load	2 amps, 24v ac max
Permanent Codes, cards and Caller ID	250
Time Restricted Codes, cards and Caller ID	250
Temporary Codes, cards and Caller ID	50

# PHASE 3

## Setup

(To be done before installing the intercom)



## GSM Coverage

Before installing this system, you need to be sure that there is good mobile GSM coverage in the area it is to be installed. It is recommended that you conduct a site survey, and check reception on the site for GSM coverage. If reception is poor in the area, then this system is not recommended.

## SIM Card

**You will require a regular voice, SMS and data NANO SIM card with an MMS plan with at least 1GB of data allowance and capable of running on 4G service.**

**Do not use a data-only SIM, as this is only for tablets and will not work in the unit.**

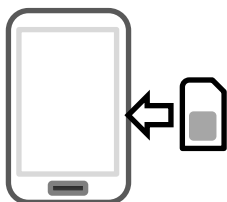

- 1) Ensure the SIM has calling credit, and can make and receive calls on a mobile phone. (pay as you go)
- 2) Check that the SIM is not locked to a phone and can be used in other devices.
- 3) Check that the SIM does not have a PIN code request.
- 4) Disable voicemail service on the SIM.
- 5) You are now ready to begin programming.

**Tip:** IoT SIMs or certain networks may not operate as expected. Please ensure you have tested using a reputable network before reporting any faults.

**If you wish to use the SIM card provided please follow the instructions with the SIM serial number. Further details can be found on our telecoms website.**

[www.aesglobaltelecom.com](http://www.aesglobaltelecom.com)

## APN Details (for VoLTE / 4G services)

To achieve a full 4G network service an Access Point Name (APN) will need to be set. The APN provides all the details that your device needs to connect to mobile data.

If you purchased the system in the below countries the APN stated will be pre-programmed for your convenience. If you purchased in a different country or wish to use a different network then the correct APN must be set for full operation.

### UK – Vodafone UK | IRL & EUR – Multi Network Sim

The modem tries to apply the correct APN for your chosen network dynamically, but this feature is not supported by all networks. A list of the most popular APNs can be found on the website above or you can contact your network provider for this information. How to apply this is shown later in the instructions.

## Inserting the SIM card

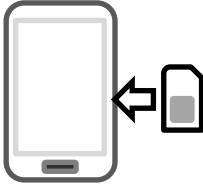

Please ensure the SIM card is a 4G NANO SIM card. Do not use a SIM card for a tablet, as these only support data, and do not support voice and SMS. You simply require a mobile phone type SIM card.

**It is always good practice to check if the SIM is active by putting it into a phone and making a call.**

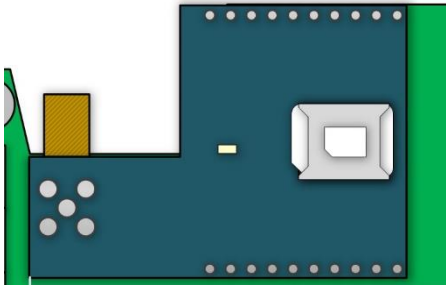

**Insert Chamfered edge first.**

**Ensure SIM is activated.  
Pre-pay SIM will need credit first.**

**WARNING**  
Ensure power is OFF. Do not hot insert or remove while power on.

## Power Connections

Perform a final check of wiring and ensure the antenna is connected before switching on the power. Once the power is switched on, the power LED should illuminate.

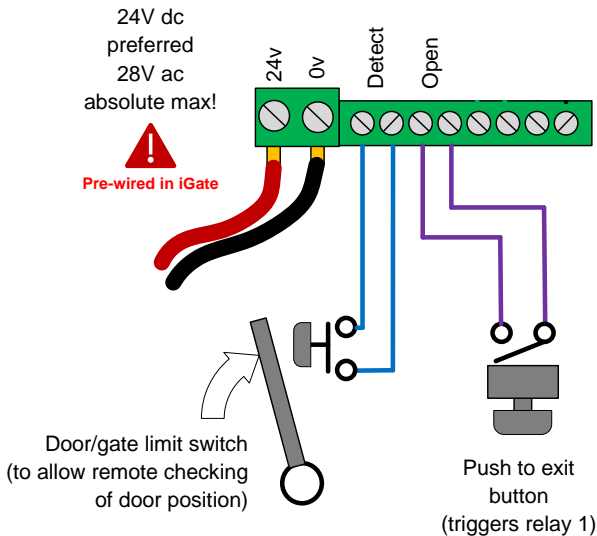

## Status LED's

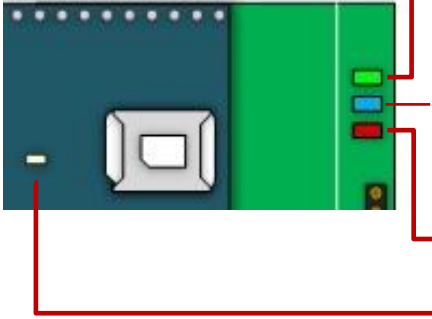

**CPU**  
 Flashing = standby  
 Constant ON/OFF = busy

**SIGNAL STRENGTH**  
 1 flash = poor (1 bar)  
 2 flashes = low (2 bars)  
 3 flashes = good (3 bars)  
 4 flashes = Strong (4 bars)

5 flashes = searching

**POWER**

**MODEM**  
 Flashing = standby  
 Constant ON/OFF = searching

Do NOT use fine gauge cable such as CAT5, CAT6, Alarm Cable etc to power this device as damage will occur.

0-2 metres (6 feet) – min 0.50mm<sup>2</sup> (18 gauge)

2-4 metres (12 feet) – min 0.75mm<sup>2</sup> (16 gauge)

4-8 metres (24 feet) – min 1.0mm<sup>2</sup> (14 gauge)



# 1: Check Reception

Go to '**Status > Signal Level**' on the AES PRO app.  
Send the pre-configured SMS string (\*20#) to the intercom.

The intercom should then reply with a signal level between 1 and 31.

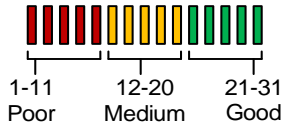

**For optimal performance, the minimum signal level required is 10 on 4G systems.**

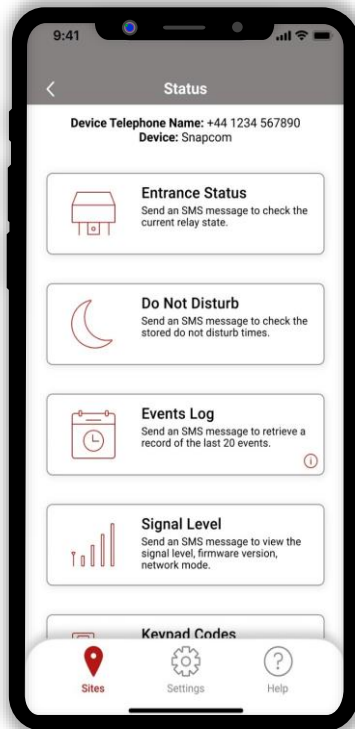

**Note:** SMS string= \*20#

## 1b: Set APN (for VOLTE / 4G service)

### i) App/SMS

If you have network mode showing 3G this feature may need to be set to achieve full 4G network service. Check the APN of your provider (can usually be found online) and then go to '**Settings > Intercom > 4G Network Features**' before entering it in the relevant section. Press confirm before sending the SMS string to the intercom.

9999#97APNinfo#  
Passcode      APN info for  
                                 SIM network  
Command  
(add APN)



### ii) Manually via Keypad

If there is no 2G/3G signal in your area the system will not be able to connect to the network at all without applying the APN.

If you purchased a unit with keypad you can contact technical support for the correct APN serial code that matches the APN for the network being used, then follow the process below:

1. Press and hold the push button before turning unit on.
2. Upon power up, a long tone will be emitted from the speaker and the blue LED will remain solid - it is now in the APN setting mode.
3. After this, enter the APN serial number through the keypad then press #. (e.g. if you want to set APN No. 18, press 1 - 8, then #. A long beep will again be heard)
4. Reboot unit.

**If the MMS Settings (\*30#) are not correct or not present after setting the APN, then this information will need programmed separately via the app. (The GSM Module is pre-loaded with and APN/MMS Settings whitelist. Setting an APN from this list will auto-fill the MMS Settings required for a visitor to receive an MMS when the push button is pressed).**

## 1c: Reboot the Intercom

The intercom will need to be rebooted after either one of the above processes is completed to log on to the network with the new APN which you have stored.

If you send another reception check (\*20#), you may find that if the network mode was on 3G before, that it is now on 4G mode.

# PHASE 4

# Installation



**ATTENTION IMPORTANT  
INFORMATION**



## ***Recommendation!***

Most technical calls received are due to installers using CAT5 or alarm cable to power the unit. Neither are rated to carry enough power (2 amp peak). Please use following cables:

0-2 (0-6 ft) use min 0.5mm<sup>2</sup> (18 gauge).

2-4 (6-12 ft) use min 0.75mm<sup>2</sup> (16 gauge).

4-8m (12-24 ft) use min 1mm<sup>2</sup> (14/16 gauge).

## ***INSECT INGRESS WILL INVALIDATE WARRANTY***

We recommend sealing all entry holes for prevention of insects that can cause issues with a risk of shorting out components.



# How to Achieve & Maintain IP55 Rating

The IP55 rating attached to this unit is only achieved if the below steps have been followed. This is to prevent any unwanted water and/or bug ingress that can cause various issues with functionality and will void the warranty if not followed.

## Step 1 – Mount to location

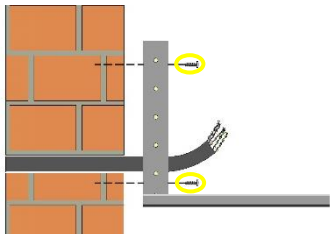

Use the provided mounting holes to attach the intercom via the chosen mounting option.

## Step 2 – Seal unit

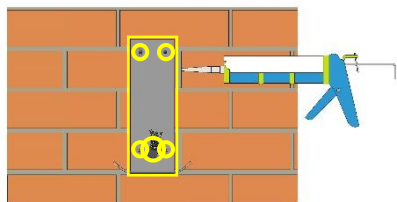

Seal all mounting or cable holes by using sealant such as silicone.

*Ensure that any products being used are safe to use as some products can cause damage to the unit and/or the mounting location.*

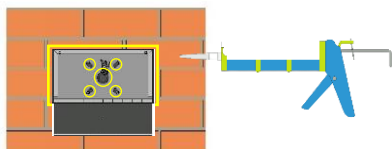

If surface mounting, seal around the back box especially when used on an uneven surface.

## Step 3 – Close unit

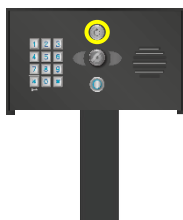

Pedestal Design



Architectural, Imperial  
& Modular Design



Flush Design

Ensure the security screws or cam lock is adequately closed to ensure a correct seal.

# Power

This intercom comes with a 24V dc power supply. The intercom requires up to 2 amps peak demand at times, therefore power cable is of extreme importance. Using insufficient power cable thickness will cause excessive stress on electronic components and can therefore void the manufacturer's warranty. To avoid such problems, it is recommended (and is good practice) to locate the power supply as close to the intercom as possible. This avoids power cable noise and interference and enhances the lifetime of the product.

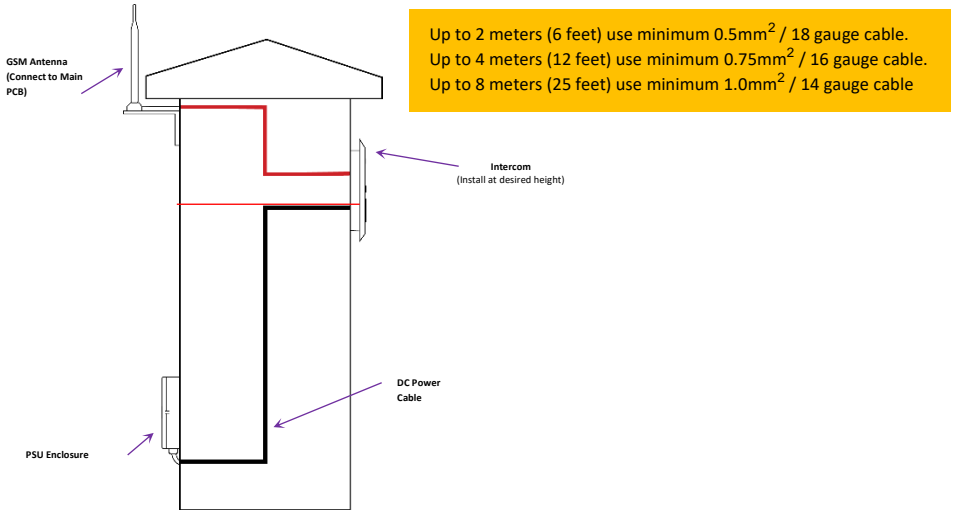

# Solar Power

You can use solar power if required. You will require a DC voltage regulator applied at the gate board end as the voltage output can vary and cause too high a voltage, which will damage the intercom if over the 26v DC.

Our systems would require as a minimum a 30W of solar panel capacity and 10Ah battery capacity for our intercoms.

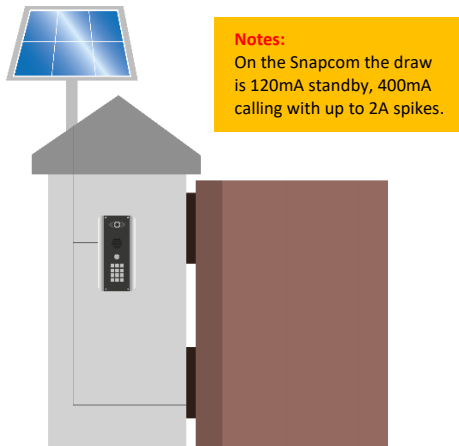



# Battery Backup Option

If you wish to prevent your intercom from losing power in the event of a power outage, we recommend using a battery backup.

**Diagrams below are for demonstrational use only**

## POWER ON

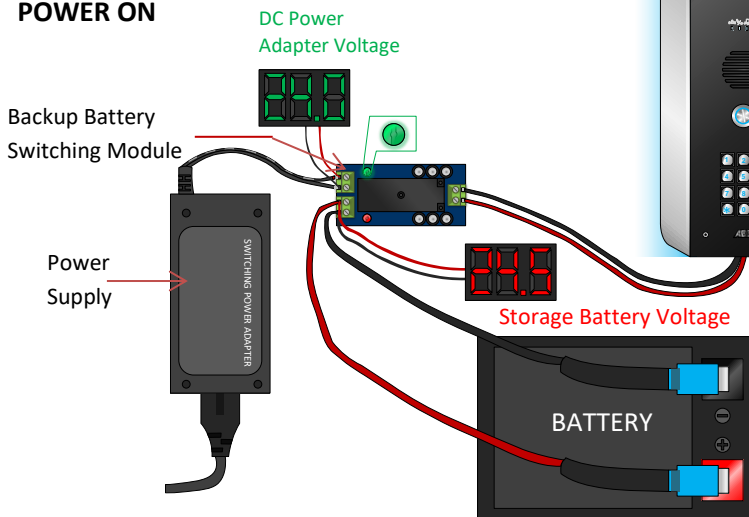

Ensure battery is regularly charged this could be done with solar power (refer to last page).

## POWER OFF

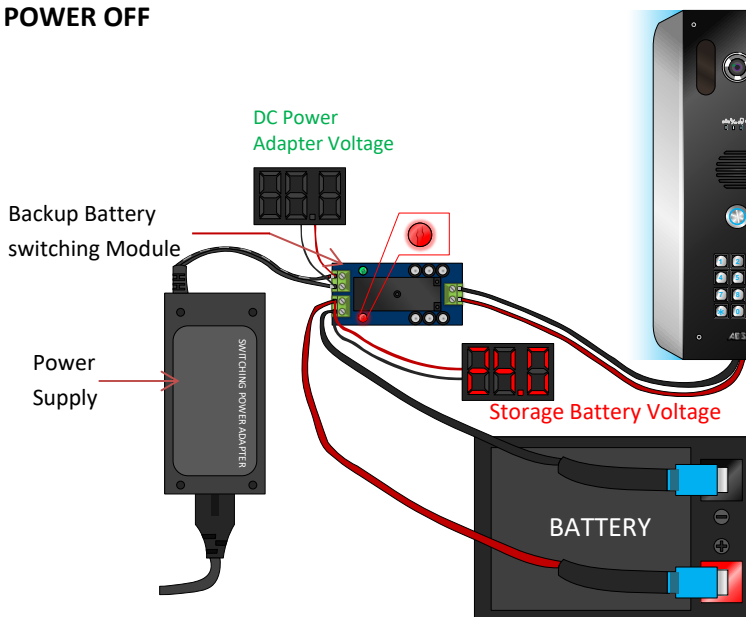

When the backup battery switching module detects a loss in power from the DC power adapter it switches over to the Backup Battery.

**Battery and switching mechanism sold separately**

## Inserting the SIM card

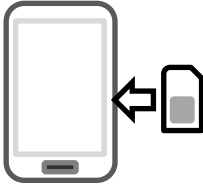

Please ensure the SIM card is a 4G NANO SIM card. Do not use a SIM card for a tablet, as these only support data, and do not support voice and SMS. You simply require a mobile phone type SIM card.

**It is always good practice to check if the SIM is active by putting it into a phone and making a call.**

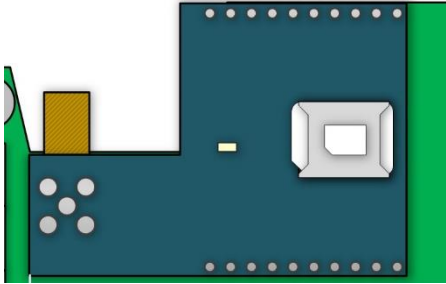

Insert Chamfered edge first.

Ensure SIM is activated.  
Pre-pay SIM will need credit first.

### WARNING

Ensure power is OFF. Do not hot insert or remove while power on.

## Power Connections

Perform a final check of wiring and ensure the antenna is connected before switching on the power. Once the power is switched on, the power LED should illuminate.

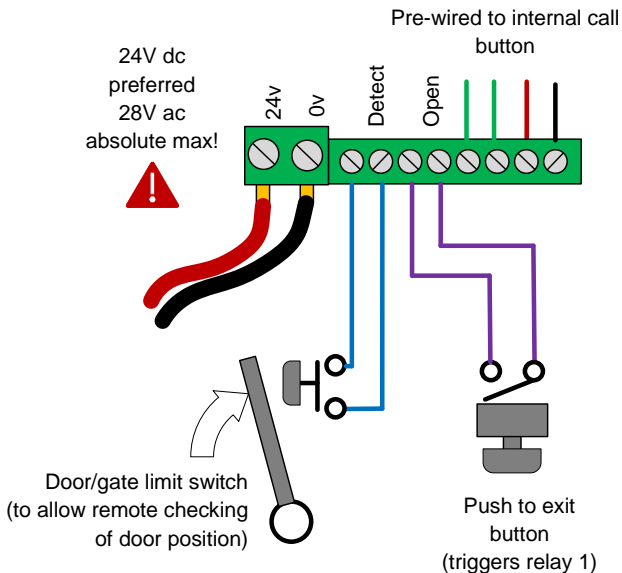

# Relay Wiring Examples

**Note:** The manufacturer is not responsible for wiring to third party devices. Please consult the device instructions if having issues.

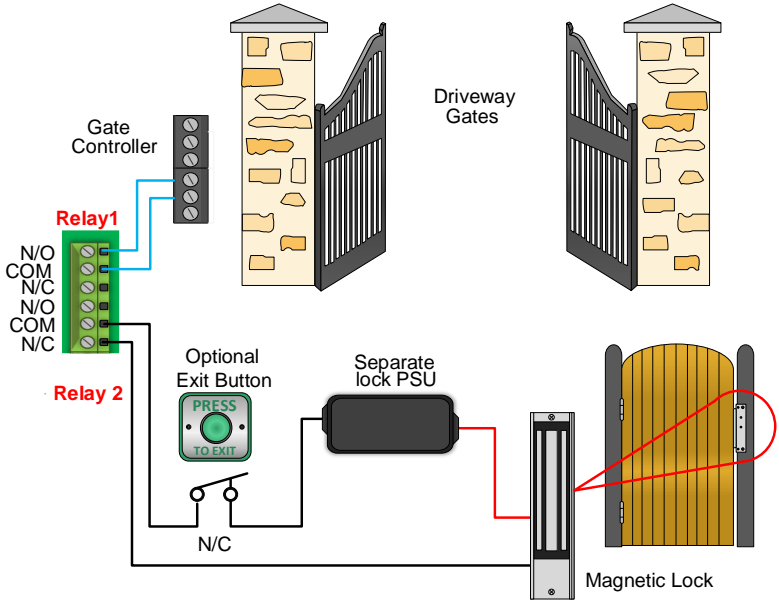

## Additional Wiring Tips

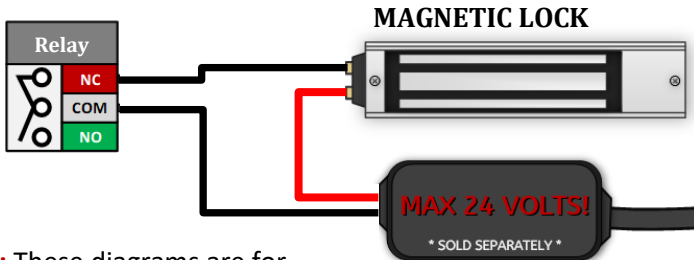
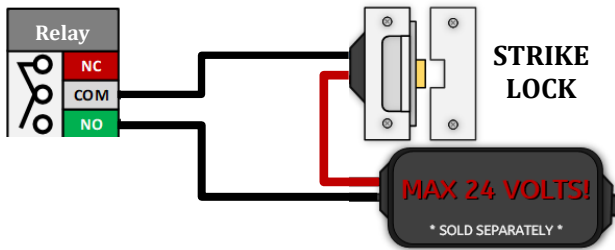

**DISCLAIMER:** These diagrams are for demonstrational use only. Please use the manufacturer's instructions provided with the lock.

# Connecting Auxiliary Devices

\*Keypad module required

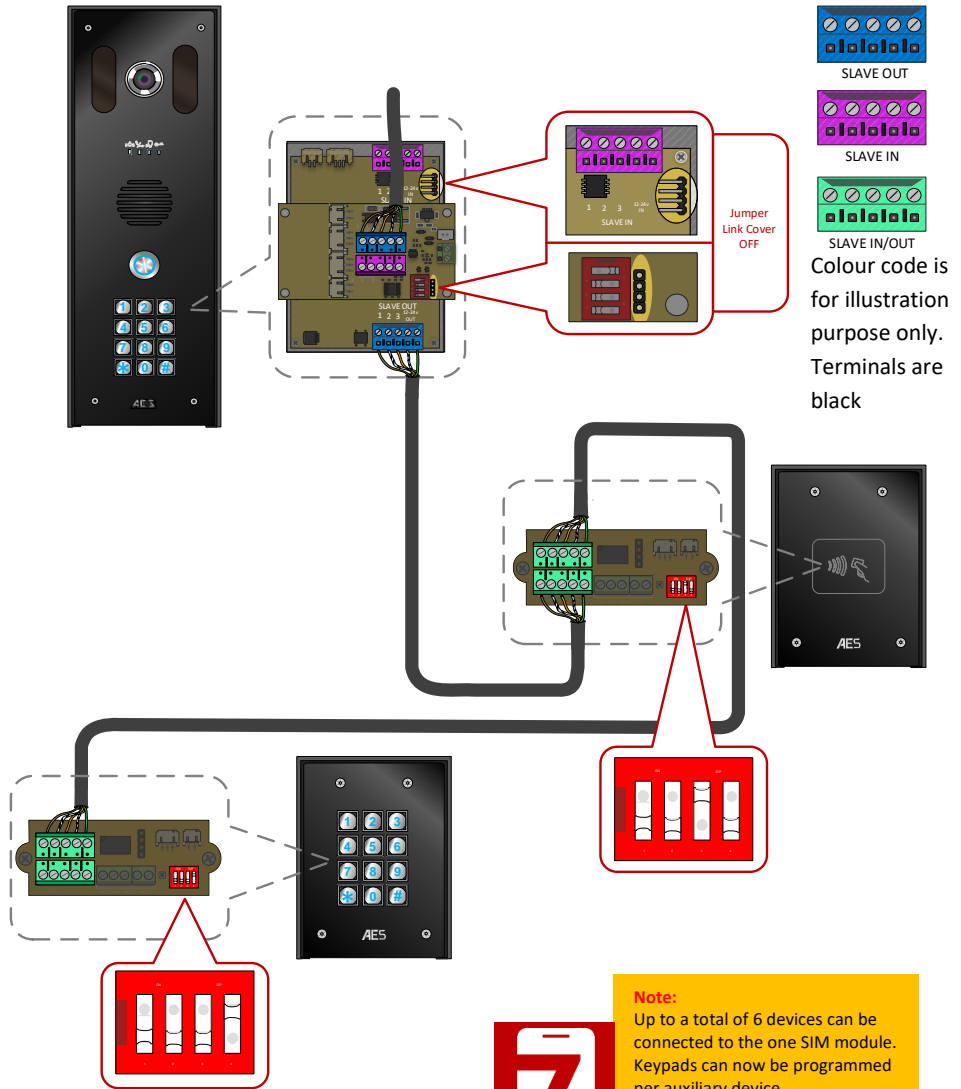

Colour code is for illustration purpose only. Terminals are black

## Note:

Up to a total of 6 devices can be connected to the one SIM module. Keypads can now be programmed per auxiliary device. Prox cards can now be programmed per auxiliary device. Power auxiliary devices separately for longer distances.



# Auxiliary Device Relay Setup

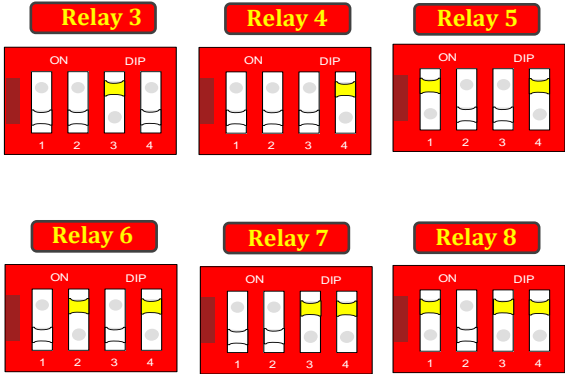

Dip switch configuration for relays 3 to 8 on auxiliary devices.

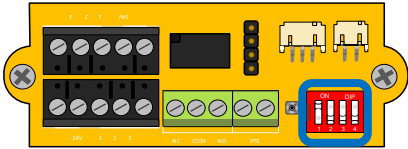

The sounder boards dip switches set the relay number for the auxiliary unit it is in.

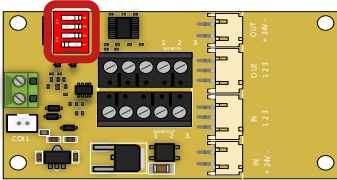

The dip switch of the prox must match the dip switch configuration of the auxiliary it wants to trigger



A keypad does not have dip switches. To assign the relay number use the keypad keys as follows.

\*#91#RelayNumber#  
(Relay Number = 3-8)

# PHASE 5

## Programming the Intercom



**TIP:** If you have already set the APN as instructed during configuration this can be skipped.

## 1b: Set APN (for VOLTE / 4G service)

### i) App/SMS

If you have network mode showing 3G this feature may need to be set to achieve full 4G network service. Check the APN of your provider (can usually be found online) and then go to '[Settings > Intercom > 4G Network Features](#)' before entering it in the relevant section. Press confirm before sending the SMS string to the intercom.

9999#97APNinfo#  
Passcode      APN info for  
                                 SIM network  
Command  
(add APN)



### ii) Manually via Keypad

If there is no 2G/3G signal in your area the system will not be able to connect to the network at all without applying the APN.

If you purchased a unit with keypad you can contact technical support for the correct APN serial code that matches the APN for the network being used, then follow the process below:

1. Press and hold the push button before turning unit on.
2. Upon power up, a long tone will be emitted from the speaker and the blue LED will remain solid - it is now in the APN setting mode.
3. After this, enter the APN serial number through the keypad then press #. (e.g. if you want to set APN No. 18, press 1 - 8, then #. A long beep will again be heard)
4. Reboot unit.

**If the MMS Settings (\*30#) are not correct or not present after setting the APN, then this information will need programmed separately via the app. (The GSM Module is pre-loaded with and APN/MMS Settings whitelist. Setting an APN from this list will auto-fill the MMS Settings required for a visitor to receive an MMS when the push button is pressed).**

## 1c: Reboot the Intercom

The intercom will need to be rebooted after either two of the above processes is completed to log on to the network with the new APN which you have stored.

If you send another reception check (\*20#), you may find that if the network mode was on 3G before, that it is now on 4G mode.

# How to Use the AES PRO App



Due to the extensive number of features included in the app we would recommend watching the selection of YouTube videos detailing the features of the app pertaining to your intercom.

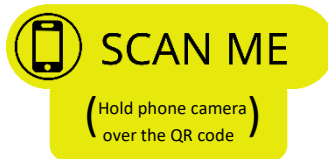

or search  
"AES Global"

This QR code will take you directly to the SnapCOM playlist on our YouTube channel which will take you through the setup and use of our new AES PRO app for a SnapCOM system.



EXTRA RESOURCES

This QR code will take you to our resource page where you can find datasheets and parameters of your intercom.



# PHASE 6

## Using the Intercom

(Only to be done after the unit is successfully programmed)

# Calling a Resident



Press the Call Button

**Tip:** Press the call button again to cancel a call

## Using Keypad Codes & Prox IDs (Keypad / Prox Units)



# Receiving A Call and Opening Gates / Door

Visitors can press the call button, which will initiate a call from your intercom to the designated phone numbers which will have been programmed by your installer.

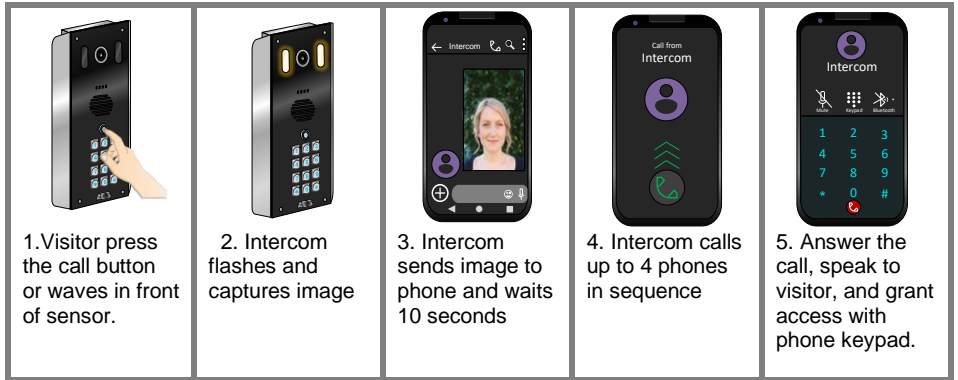

## Output 1

This is usually main gate/door.

**Press 1# to open**

Press 2# to hold open

Press 3# to un-hold

### DISABLE DTMF Confirmation

Remove the '#' confirmation. Press 1, 2, 3 to trigger, latch & unlatch.

*(False triggering may occur when disabled)*

**9999#52X#**

**(X=1 enable; X=0 disable)**

## Output 2

This can be pedestrian gate, driveway lights or other.

Press 4# to open/activate

Press 5# to hold open/on

Press 6# to un-hold/off

### ENABLE Latching feature via DTMF.

If latching is required.

**9999#95X#**

**(X=1 enable, X=0 disable)**



## Access Control by Calling the intercom (CallerID)

All residents can call the intercom to gain access at no call charge using CallerID.

To open, simply ensure you have the phone number programmed for CallerID and then call the intercom phone number from the stored number and the relay will trigger as per programmed.

**Tip:** We recommend naming your intercom in your phonebook so you can call it by voice command.



# Manager Controls of Gate / Door

This screen allows the installer or manager to manually trigger the gate.

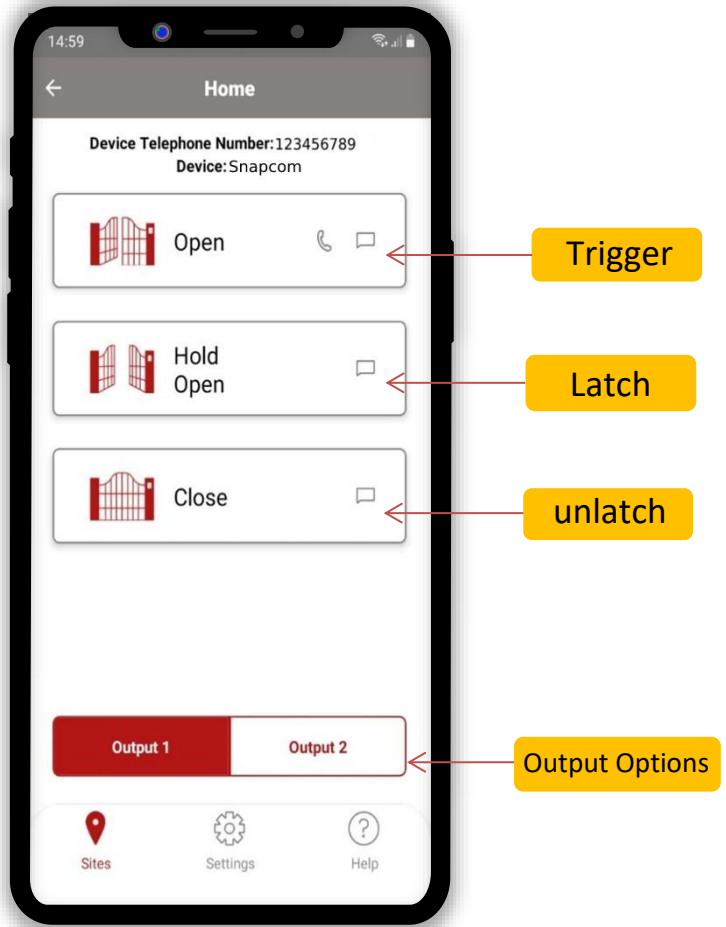

# PHASE 7

## Aftercare

# Complete List of Parameters

For a complete list of programming i.e. SMS parameters, check out our downloadable resources on our website.

## Troubleshooting

### **Q. No MMS received. SMS received stating 'Camera failure!'.**

A. This means there is an issue with the camera or camera cable. Check the camera cable connection to the board and the camera. Check the cable cores are seated correctly in the connector.

### **Q. The intercom dials out but no MMS is received.**

A. Ensure all MMS settings have been programmed. These can be checked via the \*30# command. Check for errors; lower/upper case letters can affect the MMS operation. Check the settings with your SIM card provider.

### **Q. Not enough time to view visitor before incoming call.**

A. Increase delay time for calling out after MMS sent. This can be done with the following SMS string: 9999#07X# where the X is equal to time in seconds (1-15).

### **Q.MMS received but not downloaded.**

A. Phone has no mobile data to use. Turning on mobile data will allow you to download the image. Ensure mobile data allowance has not expired.

### **Q. The unit will not power up. No LEDs on.**

A. Check power supply voltage at intercom is 23.4v DC or more. Cable length from PSU to intercom should be less than 8 metres and in 1.0mm<sup>2</sup>/14 gauge for longer distances. See guide. Check the fuse (if applicable).

### **Q. The unit powers up but is not showing network reception or will not respond to SMS. (No green CPU light).**

A. This means the unit is not able to detect the network for some reason.

- Power off the unit, remove the SIM and check it in a mobile phone to verify it can make a call and has calling credit if it is a Pay As You Go SIM.
- Disable any PIN code request if active on the SIM card.
- Check the SIM is a standard voice capable SIM. If you are unsure, contact your SIM card provider to verify.
- Check the reception is medium or good. Poor reception is not sufficient.
- Check antenna is connected and does not have too many sharp bends on the antenna cable.
- Check the height of the antenna and make sure it is not inside a metal enclosure.
- Check correct power cable size for cable length from PSU. Refer to manual for guidelines

### **Q. The unit calls the first number, but there is not enough time to answer before it diverts to the next number.**

A. Increase the ringing time as per the SMS Parameters/ Settings section of AES PRO app.

**Q. The unit calls the first number, but voicemail comes on before it can ring the second number.**

A. Decrease the ringing time as per the SMS Parameters/ Settings section of AES PRO app.

**Q. The caller ID function does not work.**

A. If your number is private or number withheld, then it will not work.

-Ensure the number is entered as you would normally dial it from another phone.

-For International customers, ensure the numbers have been entered with their international dialling code. If this does not work, try again without.

**Q. There is no audio from the gate, but the person at the gate can hear ok.**

A. This can be due to low reception or excessively long power cables.

-Check reception level by \*20#.

-Change SIM card if necessary, to another network that may have better coverage.

-Purchase a high gain antenna.

This may also be caused by a defective microphone, water on a microphone from a sprinkler for example, or dirt/insects blocking the microphone hole. If reception is optimum and the problem persists, contact your supplier or installer.

**Q. The audio quality that can be heard on the remote telephone is poor or humming (buzzing).**

A. A small amount of GSM buzz can be considered normal on GSM intercoms, but not so much that causes an inability to hear the person speaking. This is a symptom of poor reception. Try the above steps on checking and improving reception. Consider fitting an external high gain antenna. Move the antenna further away. Remove any short bends in the antenna. Ensure the spare antenna cable is not rolled up inside the call station.

**Q. The trigger keys do not work when the intercom calls a phone.**

A. Check if you can hear the relay clicking at the gate when the keys are pressed during a call. If it can be heard, then the system is working, check to wire between the relay and the lock or gate panel. If the relays do not make a clicking sound, then check this feature on a different mobile cell phone or landline. If it works on a different phone, check the settings on the phone in question under DTMF tones.

Failure of DTMF tones to operate correctly is also a symptom of low reception or insufficient power cabling. Check the steps above on improving reception or addressing the power problem.

-Also check that the relays are not already latched with the \*22# command. If they are latched, they need to be unlatched before the trigger keys will work.

-Sometimes excessively long power cables or thin power cables can cause this problem. Prove it by connecting a temporary extension lead and the power supply directly to the unit.

- Check relay 1 & 2 with multi-meter. If relay 2 works but relay 1 does not, then relay 1 may be defective.

-Check if it works by SMS. Try latching a relay then use the status button to check if the relay is latched. If that works, the problem could be the phone being used, or low signal strength at the intercom.

**Q. The system was operating the gates fine, but now it will not trigger the gates.**

99% of the time, this is caused by the user accidentally latching the relay. This latches the output relay permanently on. Send the intercom the following SMS \*22#. The intercom should reply with a message detailing the relay status. If it has been latched, then the message will state “the relay is ON”. In this case, refer to the user guide to read how to unlatch it again.

**Q. The unit no longer calls out to phones but I can make a call to it from my phone.**

A. Check there is a balance on the SIM card.

A. Switch off the power, remove the SIM, put it into a phone, and check that a call can be made from a phone. This will verify if the SIM is still working and in service.

**Q. Forgot Engineers code for SMS programming**

A. You will need to complete a hard reset by following the steps below.

*Note this will erase all data stored on the PCB.*

- 1) Power off the unit. (approx 60 secs)
- 2) Link the terminals marked OPEN.
- 3) Switch on the power
- 4) After several seconds the relay will click.
- 5) The unit will then clear memory and be defaulted
- 6) Remove the link and wait around 20 seconds.
- 7) Reboot the unit for good measure

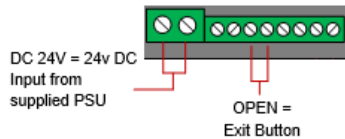



# Firmware Updates

## Option 1: FOTA (Firmware Over The Air)

FOTA allows you to update your intercom wirelessly without a PC.

First, you should check the firmware version on your intercom with **\*20#**. If the firmware doesn't have (FOTA) after it, then the firmware will need updated manually to enable this feature (see overleaf).

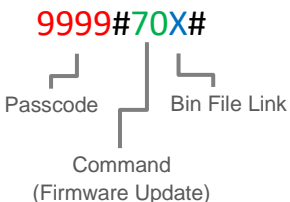

**Tip:**  
Set APN before  
sending FOTA SMS!

Text string to use to get our latest firmware:

**9999#70<http://23.105.204.41:2346/AES/Snapcom-Prime/Latest#>**

**\*\*DO NOT TURN OFF YOUR INTERCOM DURING THE UPGRADE PROCESS\*\***

**\*\*ADDITIONAL DATA CHARGES MAY APPLY\*\***

Although unlikely due to the small update file size.

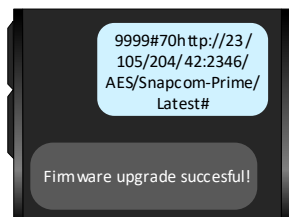

## Option 2: Manually Update Via Laptop and USB B Cable

Firmware updates will be released to fix any bugs or to add additional features where possible throughout the product's lifetime.

The firmware version your system is using can be found by sending the system status message (\*20#).



The most recent firmware version will be available via the AES website along with details of any changes made. The updates will need to be loaded on manually using a PC and USB-B cable or a serial connector.

Although most firmware updates are to add or alter features if you find your intercom is on older firmware and are suffering from issues it may be worth following the details below.

### **\*\*ATTENTION\*\***

**PLEASE ENSURE YOU HAVE ALL YOUR DATA BACKED UP IN THE INSTANCE THE DETAILS ARE LOST DURING THIS PROCESS.**

This is a precautionary measure as in most cases the data is kept intact after a firmware update.

<p><b>Upgrade Cable</b> (USB B-type Cable)</p>	<p><b>Windows Laptop/PC (Windows 10 or later).</b> (USB connection required) (Firmware Burner PC Program, New Firmware File)</p>
	

## Step 1: Connect

- (a) Connect USB B-type cable to Windows PC/laptop (Windows 10 or later).
- (b) Connect USB cable to port as shown below. (This can be done while the unit is powered on).

**\*\*The intercom will need to be powered on before upgrading can begin\*\***



**\*\* Images are for illustration purposes only.\*\***

## Step 2: Download

- (a) Download the 4G Upgrade Tool from the AES Global website. Found here: <https://aesglobalparts.com/pages/gsm-resources-1>
- (b) Save the zip file to a location of your choice.
- (c) Right click on the zip file and click 'Extract Here'.

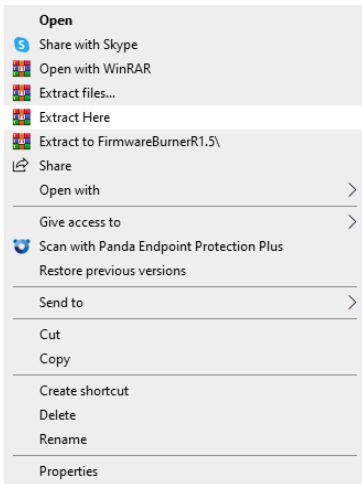

A software to extract the files may be required such as WinZip or 7zip.

- (c) Click on the extracted folder 'FirmwareBurnerR1.5', then the Application file.

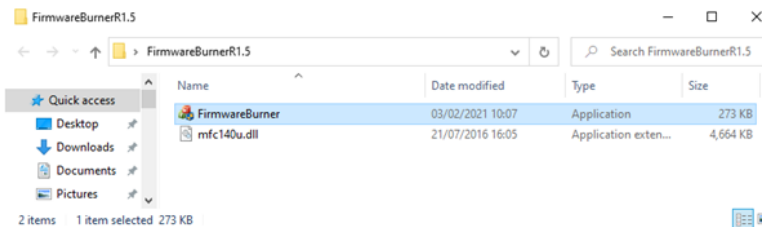

- (d) Allow the app to 'make changes to your device', when prompted.

### Step 3: Upgrade

- (a) 4G Upgrade Tool will load as shown below.
- (b) Enter the 4 digit Programming Passcode and click 'Connect'.
- (c) Check the latest firmware version on the board.  
\*\*Available to view on most recent firmwares only.\*\*
- (d) Click 'Flash', locate the firmware file (bin file format), and wait for the upgrade to complete (PCB will auto reboot after upgrade).
- (e) Close the 4G Upgrade Tool and remove the USB lead from the board.

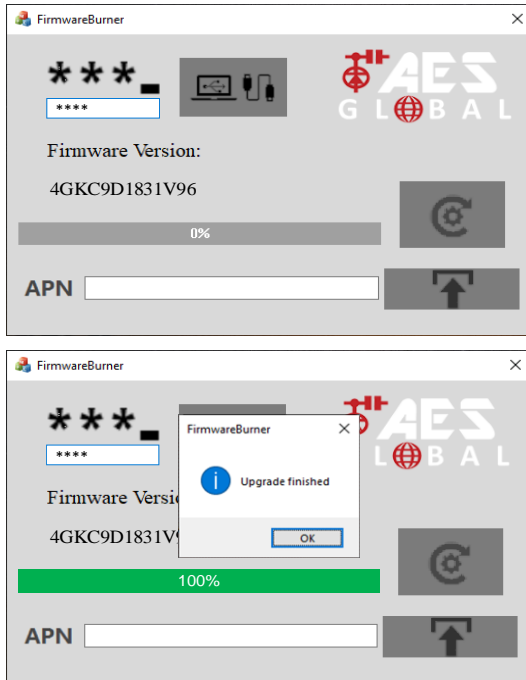

\*\*Default Programming Passcode/ Engineers Code is 9999.\*\*

**Tip: After PCB reconnects to network, reopen Upgrade Tool, Connect and check new firmware version.\*\***

Send the SMS for signal level to the unit to find the firmware version now installed. (\*20#)

# App Updates

We will continually monitor the app's performance and will release updates to enhance the user's experience and/or fix any issues that arise over time. These updates will be available via the iOS app store or the Android Play store. Enabling auto updates is recommended for the most up to date experience.

## Extra Resources

Find all our support resources on our website or scan the QR code below.



EXTRA RESOURCES

## Intercom Maintenance

Bug ingress is a common issue in unit failures. Ensure that all components are sealed accordingly and check occasionally. **(Do not open the panel in the rain/snow unless correctly equipped to keep the internals dry. Ensure the unit is securely closed after maintenance)**



We recommend sealing all entry holes for prevention of insects that can cause issues with a risk of shorting out components.

To maintain the IP55 rating please follow the sealing instructions included. (also available online)

If you have an AB, AS, ABK, ASK call point it will have silver edges which are marine grade stainless steel so in normal weather conditions should not rust however it can dull or discolour over time. This can be polished with a suitable stainless-steel cleaner and cloth.

## Environmental Information

The equipment that you bought has required the extraction and use of natural resources for its production. It may contain hazardous substances for the environment. To avoid the dissemination of those substances in our environment and to diminish the pressure on natural resources, we encourage you to use the appropriate take-back systems. Those systems will reuse or recycle most of the materials of your end-of-life equipment.

The crossed-bin symbol marked in your device invites you to use those systems.



If you need more information on the collection, reuse and recycling systems, please contact your local or regional waste administration. You can also contact AES Global Ltd for more information on the environmental performances of our products.

# Documentation Feedback

We are constantly working to produce the highest quality documentation for our products. We welcome your feedback. Send us your comments or suggestions about our online Help, printed, or PDF manuals.

Please include the following information with your feedback:

- Product name and version number
- Type of document: printed manual, PDF, or online Help
- Topic title (for online Help) or page number (for printed or PDF manuals)
- Brief description of content (for example, step-by-step instructions that are inaccurate, information that requires clarification, areas where more detail is needed, and so on)
- Suggestions for how to correct or improve the documentation

We also welcome your suggestions for additional topics you would like to see covered in the documentation.

Send email feedback to: [docfeedback@aesglobalonline.com](mailto:docfeedback@aesglobalonline.com)

Please keep in mind that this email address is only for documentation feedback and will not be responded to unless we require more details. If you have a technical question, please contact the technical department.

# Warranty

Please note, by installing this product, you are accepting the following warranty terms:

1. The manufacturer's warranty is a "return to base" 2-year warranty from the date of manufacture. This means that any suspected defective components or items are returned to the manufacturer's agent for investigation and diagnosis and returned at the cost of the customer.
2. The warranty does not cover, nor is the manufacturer or agent responsible for any of the following whatsoever: Storm damage, lightning or surge damage, flooding, accidental damage, vandalism or deliberate damage, un-explained corrosion or unusually harsh environments, failure of telephone networks, future un-interoperability between the product and network providers which cause malfunction due to changes implemented by the phone providers after manufacturing of the product, or that which is outside of the control of the manufacturer (e.g. 2G, 3G switch off, removal or inability to obtain VOLTE service), and damage due to not proper installation.
3. The manufacturer in no way accepts liability for any of the following incurred due to a product defect: Cost of attending site, inconveniences, labour rates, time lost, loss to or damage to property, security breaches, late payment clauses or breaches of any contracts between the installer and the client.
4. This is a professional install product only. The product is a component of an overall system. Therefore, it is the responsibility of the installer to certify the safety and compliance of the overall finished system. As soon as this product is fixed to another item, or connected to another third-party device, then the product has been modified, and compliance with local regulations in the country of install is strictly the responsibility of the installer.
5. Re-stocking fees may apply to items returned that are found to be non-defective. Complete units will also attract a re-stocking fee if returned for credit, regardless if a defect is discovered or not. Re-stocking fees may vary depending on the condition of the item being returned, and whether it can be determined as in brand new condition. The warranty terms do not entitle customers to an automatic full refund. For more details on returns procedures and re-stocking fees, contact the agent.
6. Items with physical signs of surge damage are not covered by warranty. Items with visible signs of surge damage will only be covered by warranty if photographic evidence is provided from the site, showing surge protection has been installed.

Full warranty terms and conditions are available upon request to AES Technical Department.



## Free Extra 1 Year Warranty



If you register with us within 90 days of purchase and provide proof of purchase, you will be eligible for an extra year of warranty.



SCAN ME

This QR code will take you to the warranty section of our website. You can access the form for the warranty by scrolling to the bottom of the section and pressing the “Extra year warranty” button.

**\*\*Only available in selected countries\*\***

**LEFT  
BLANK**

**LEFT  
BLANK**

# Regulatory Compliance

## EU-RED Declaration of Conformity

Manufacturer: Advanced Electronic Solutions Global Ltd  
Address: Unit 4C, Kiltcronagh Business Park, Cookstown, Co Tyrone, BT809HJ, UK  
We/I declare, that the following equipment (GSM Cellular Intercom System), part numbers:  
Multiple Model kit part numbers: PRIME6-MULTI-LT-4GE.

Complies with the following essential requirements for 2014/53/EU:

ETSI draft EN 301 489-1 V2.1.1 (2017-02) (Electromagnetic compatibility)  
ETSI draft EN 301 489-52 (2016-11) (Electromagnetic compatibility, specific to cellular)  
(2G bands 900/1800, 3G band 1,8 LTE bands 1, 3, 7, 8, 20).  
Test report number LCS181101028AEA

ETSI EN 301 511 V12.5.1 (2017-03) (3.2 of directive 2014/53/EU)  
ETSI TS 151 010-1 V12.8.0 (2016-05) (Digital cellular telecoms compliance)  
Test report number LCS181101028AEB

ETSI EN 301 908-1 V11.1.1 (2016-07) (IMT Cellular networks, 3.2 of directive 2014/53/EU)  
ETSI EN 301 908-2 V11.1.2 (2016-07) (CDMA spread / UTRA FDD)  
Test report number LCS181101028AEC

ETSI EN 301 908-13 V11.1.2 (2017-07) (E-UTRA and UE standards)  
Test report number LCS181101028AED

EN 62311 :2008 (Electromagnetic safety and human exposure)  
Test report number: LCS181101028AEE

EN 60950-1, (A1, A11, A12, A2)  
EN 62311

I  
EC 60950 (IT equipment safety)  
Test report number: LCS181101029AS

The notified body is: Micom Labs (CAB number 2280).  
This declaration is issued under the sole responsibility of the manufacturer.  
Signed by:



Paul Creighton, Managing Director. Date: 4th Dec 2018

*This product is not complete until fully installed. It is therefore considered a part of an overall system. The installer is responsible to check that the end installation complies with local regulatory requirements. This equipment forms part of a "fixed installation"*

## NEED MORE ASSISTANCE?

**+44 (0)288 639 0693**

*The manufacturer cannot legally offer technical support to non-qualified gate or door installers. End users should employ the services of a professional installation company to commission or support this product!*

